



Altivar Machine ATV340

Variable speed drives for
high-performance machines

Quick access to product information

Get technical information about your product

References

Modicon TM3
I/O expansion modules for Modicon controllers
Analog I/O modules

| Reference | Number and type of channels | Output range | Resolution | Input terminal block | Reference | Weight (kg) |
|-------------------------------|--|---|------------|----------------------|-------------|-------------|
| 2 channel general purpose | 2 x 16-bit DAC 0...100% V _{ref} / 0...20 mA | 16-bit DAC 0...100% V _{ref} / 0...20 mA | 16-bit DAC | 5-pin | Modicon TM3 | 0.150 |
| 4 channel general purpose | 4 x 16-bit DAC 0...100% V _{ref} / 0...20 mA | 16-bit DAC 0...100% V _{ref} / 0...20 mA | 16-bit DAC | 5-pin | Modicon TM3 | 0.200 |
| 8 channel general purpose | 8 x 16-bit DAC 0...100% V _{ref} / 0...20 mA | 16-bit DAC 0...100% V _{ref} / 0...20 mA | 16-bit DAC | 5-pin | Modicon TM3 | 0.250 |
| 16 channel general purpose | 16 x 16-bit DAC 0...100% V _{ref} / 0...20 mA | 16-bit DAC 0...100% V _{ref} / 0...20 mA | 16-bit DAC | 5-pin | Modicon TM3 | 0.300 |
| 2 channel temperature inputs | 2 x 16-bit ADC 0...100% V _{ref} / 0...20 mA | 16-bit ADC 0...100% V _{ref} / 0...20 mA | 16-bit ADC | 5-pin | Modicon TM3 | 0.150 |
| 4 channel temperature inputs | 4 x 16-bit ADC 0...100% V _{ref} / 0...20 mA | 16-bit ADC 0...100% V _{ref} / 0...20 mA | 16-bit ADC | 5-pin | Modicon TM3 | 0.200 |
| 8 channel temperature inputs | 8 x 16-bit ADC 0...100% V _{ref} / 0...20 mA | 16-bit ADC 0...100% V _{ref} / 0...20 mA | 16-bit ADC | 5-pin | Modicon TM3 | 0.250 |
| 16 channel temperature inputs | 16 x 16-bit ADC 0...100% V _{ref} / 0...20 mA | 16-bit ADC 0...100% V _{ref} / 0...20 mA | 16-bit ADC | 5-pin | Modicon TM3 | 0.300 |

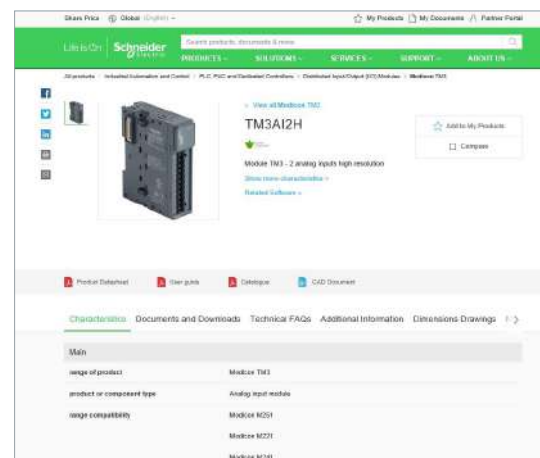

Each commercial reference presented in a catalog contains a hyperlink. Click on it to obtain the technical information of the product:

- Characteristics, Dimensions and drawings, Mounting and clearance, Connections and schemas, Performance curves
- Product image, Instruction sheet, User guide, Product certifications, End of life manual

Find your catalog

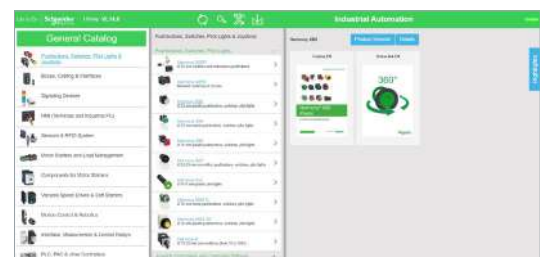
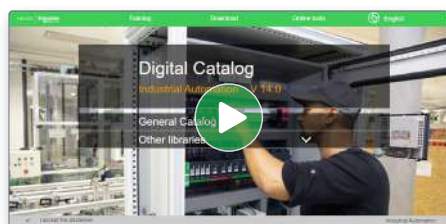

- > With just 3 clicks, you can access the Industrial Automation and Control catalogs, in both English and French
- > Consult digital automation catalogs at [Digi-Cat Online](#)

- Up-to-date catalogs
- Embedded product selectors, 360° pictures
- Optimized search by commercial references

Select your training



- > Find the right [Training](#) for your needs on our Global website
- > Locate the training center with the selector tool, using this [link](#)



Life Is On

Schneider Electric

mySchneider, your personalized digital experience

Access an all-in-one customized online experience and benefit from tailored business services, resources, and tools to efficiently support your business operations.

- **Efficiency:** In just a few clicks, find all the information and support you need to get the job done.
- **Simplicity:** Use a single login to access all business services, in one place, available 24/7. You no longer need to log in to multiple platforms.
- **Personalization:** Benefit from content, tools, and business services tailored to your activity, and customize your landing page based on your preferences.

Watch the How-to Videos



Order management

- > [Select Products and Add to Cart](#)
- > [Check for Products' Price and Availability](#)
- > [Order Products with Generic Commercial References](#)



Product information

- > [Find a Product Data Sheet and Related Documents](#)
- > [Select Products and Add to Cart](#)
- > [Stay Up to Date on the Status of My Products](#)



Support

- > [Get Quicker Answers Thanks to Online Support](#)

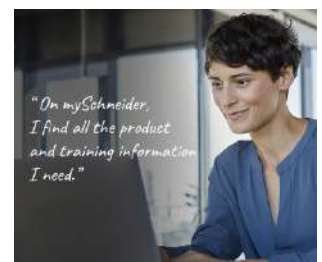

Training

- > [Access Trainings Dedicated to My Activity](#)

[Create your account](#)

Life Is 

Schneider
Electric



Altivar

Discover [Altivar](#)

Variable speed drives and soft starters

Improve your energy efficiency and sustainability with Altivar variable speed drives and soft starters. Manage motor control applications up to 20 MW with products ranging from compact products to custom-engineered solutions. Our connected devices offer built-in intelligence to improve operational efficiency, availability, and functional safety in various application areas, such as industrial processes, machines, or buildings.

Explore our offer

- [Altivar Process](#)
- [Altivar Machine](#)
- [Altivar Building](#)
- [Altivar Soft Starters](#)

Life Is 

Schneider
Electric

General contents

Altivar Machine ATV340 variable speed drives

Introduction to EcoStruxure Machine page 2

■ Presentation

□ General presentation page 4

Altivar Machine variable speed drives selection guide page 12

□ Altivar Machine variable speed drives presentation page 14

■ Variable speed drives

□ Presentation page 18

□ Description page 21

□ References page 22

□ Configuration and runtime tools page 27

■ Options

□ Drive/option combinations page 33

□ Encoder interface modules page 37

□ Additional I/O modules page 38

□ Communication buses page 39

□ Safety modules page 45

□ Additional module support page 47

□ Braking resistors page 49

□ EMC filters page 51

□ Line chokes page 53

□ dv/dt filters page 55

□ Common mode filters page 56

□ ATV Regenerative units page 57

■ Motor starters

□ Three-phase supply voltage 380...415 V 50/60 Hz page 59

□ Three-phase supply voltage 440 V 50/60 Hz page 60

■ Dimensions page 61

■ Services page 66

■ Index page 68

To be competitive in today's digital era, machine builders must be innovative. Smart machines, those that are better connected, more flexible, more efficient, and safe, are enabling machine builders to innovate in ways never before possible.

EcoStruxure, Schneider Electric's open, IoT-enabled architecture and platform, offers powerful solutions for the digital era. As part of this, EcoStruxure Machine brings powerful opportunities for machine builders and OEMs, empowering them to offer smart machines and compete in the new, digital era.

EcoStruxure Machine brings together key technologies for product connectivity and edge control on premises, and cloud technologies to provide analytics and digital services. EcoStruxure Machine helps you bring more innovation and added value to your customers throughout the entire machine life cycle.

Innovation at Every Level for Machines is full systems across three layers:

- Connected products
Our connected products for measuring, actuating, device level monitoring, and control adhere to open standards to provide unmatched integration opportunities and flexibility
- Edge Control
We are IIoT-ready with a proven set of tested and validated reference architectures that enable the design of end-to-end open, connected, and interoperable systems based on industry standards. Ethernet and OPC UA facilitates IT/OT convergence meaning machine builders reap benefits from web interfaces and cloud.

- Apps, Analytics & Services
Seamless integration of machines to the IT layer allows the collection and aggregation of data ready for analysis – for machine builders and end users alike this means increased uptime and the ability to find information faster for more efficient operations and maintenance.

These levels are completely integrated from shop floor to top floor. And we have cloud offers and end-to-end cybersecurity wrapped around.

EcoStruxure Machine makes it easier for OEMs/ machine builders to offer their customers smarter machines. The advent of smart machines is driven by the changing needs of end users:

- Evolving workforce
- Reducing costs
- Dynamic markets
- Shorter life cycles
- Prioritizing functional safety and cybersecurity

EcoStruxure Machine provides one solution for the whole machine life cycle:

- With Smart Design & Engineering the time to market is reduced by up to 30% using our automated engineering and the simulation capabilities
- During Commissioning & Operation of the machine, resources such as energy, material and loss can be improved, and with seamless integration to the IT world efficiency can be improved by up to 40%
- Smart Maintenance & Services reduces the time for corrective actions up to 50%

EcoStruxure™ Machine



Altivar Machine

Next level of automation performance

Altivar Machine drives offer extensive flexibility in machine applications. Depending on customer requirements, Ethernet embedded drives are available up to 75 kW and Modular and Sercos drives are available up to 22 kW.

Modular drives from 0.75 kW to 22 kW/
1HP to 30 HP
Ethernet drives from 0.75 kW to 75 kW/
1HP to 100 HP
Sercos drives from 0.75 kW to 22 kW/
1HP to 30 HP



Latest innovations
with up-to-date
technology

Altivar Machine ATV340 drives

220%

Nominal torque
for 2 s

1 ms

Application
cycle time

Advanced machine performance

Powerful dynamism and scalability

Altivar Machine ATV340 is a powerful drive that aims to match your machine's motor capabilities with maximum torque and speed performance.

With an optimized speed bandwidth up to 400 Hz, the Altivar Machine ATV340 is designed for dynamic applications that may require faster acceleration or settling time.

- > Robust enough to withstand high overloads, adaptable to the needs of demanding applications, it can provide up to 220% nominal torque for 2 s.
- > Compatible with a wide range of motors, including asynchronous (IE2, IE3) motors, synchronous motors, and reluctance motors for various applications in closed (1) and open loop, to provide the adaptability and scalability your machine requires.
- > Combination of ATV340 minimum application reaction time (1 ms task cycle) and Ethernet or Sercos connectivity, maximizing your machine throughput.

(1) Not supported by Sercos drives.



Reduced machine design time

Altivar Machine ATV340 drives will help reduce your engineering time at every stage of the process to speed up machine activation and operation.

Simplified machine engineering

Altivar Machine ATV340 accommodates numerous functions and features to simplify machine design and reduces the engineering time from selection to commissioning.

- > A wealth of interfaces, numerous I/O, multi-Ethernet protocol, Sercos protocol, PTI/P TO, embedded encoders and multiple option interfaces offer maximum flexibility in architecture design.
- > Simple master/slave configuration, integrated application functions facilitate and fulfill application performance for hoisting, material handling, material working, and packaging machine segments.

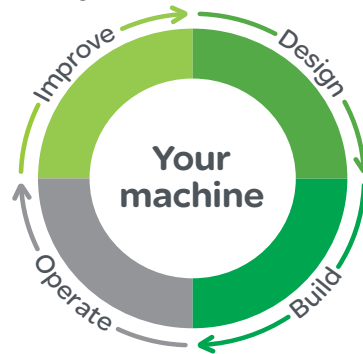

Reduced machine design time helps increase operation efficiency



TVDA's are combinations of Schneider Electric best-in-class products providing typical control architectures



FDT Technology: A widely-accepted international standard

Seamless automation integration

Ready-to-use MachineStruxure application libraries that are Tested, Validated, and Documented (TVDA), combined with Ethernet services available in ATV340, will facilitate your machine design and help you significantly reduce design time.

- > FDT/DTM technology helps ensure the interoperability and user-friendliness of ATV340 in architectures with third-party PLCs. For Sercos drives, FDT/DTM is used over Modbus serial line.
- > One button auto-tuning for motor identification simplifies commissioning and makes it possible to replicate the complete project in a fast and seamless manner for maximum productivity in machine production.

Online tools for designing and assessing

Altivar Efficiency Calculator tool calculates the level of energy efficiency of your variable speed drive according to the Ecodesign standard EN/IEC 61800-9-2, based on 8 operating points considering torque and speed. It evaluates both Drive Efficiency (CDM Complete Drive Module) and System Efficiency (PDS Power Drive System), including the efficiency of the variable speed drive and its motor.



Calculate your level of energy efficiency with the Altivar Efficiency Calculator

EcoStruxure Motor Control Configurator tool helps you build a complete motor control solution in three steps, by selecting:

- > Motor power
- > Industrial segment and process
- > Application



Configure your Altivar drive with the EcoStruxure™ Motor Control Configurator

Reduced machine design time (continued)

Modicon M262 Logic controller in a Tested Validated & Documented Architecture (TVDA)

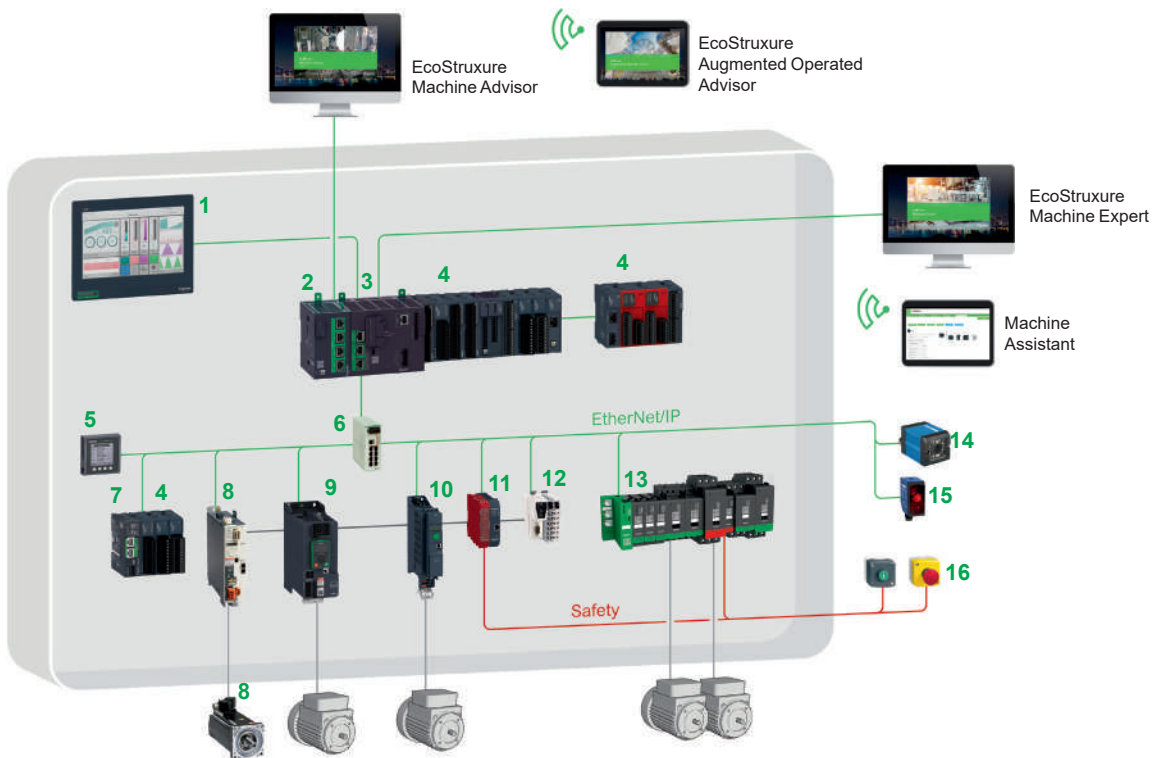

Solution breakdown (1)

- | | |
|---|---|
| <ul style="list-style-type: none"> 1 Harmony iPC: Touchscreen display 2 Modicon TMSES4 Ethernet smart communication module 3 Modicon M262 Logic controller 4 Modicon TM3 expansion modules (digital, analog, Expert, and Safety I/O) 5 Power meter 6 Modicon Ethernet managed switch 7 Modicon TM3 Ethernet bus coupler 8 Lexium 32M servo drives and BMH/BSH servo motor | <ul style="list-style-type: none"> 9 Altivar Machine ATV340S variable speed drive 10 Altivar Machine ATV320 variable speed drive 11 XPSMCM modular Safety controller 12 Modicon TM5 Ethernet interface module 13 TeSys island load management system 14 Barcode reader 15 Proximity sensors 16 Harmony® XB5 plastic pushbutton and Emergency stop |
|---|---|



(1) Please refer to our catalogs on [Digi-Cat](#)

Reduced machine design time (continued)

Modicon M262 Motion controller in a Tested Validated & Documented Architecture (TVDA)

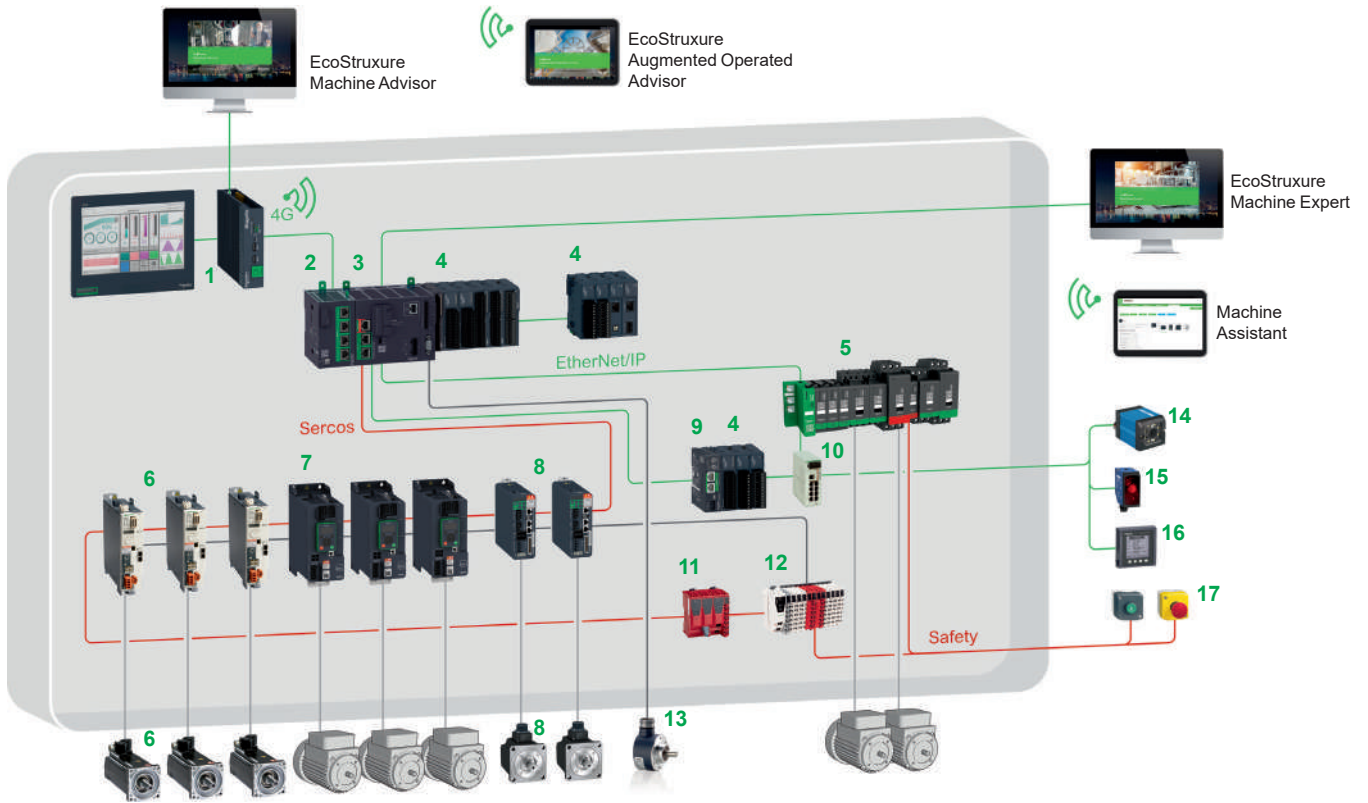

Solution breakdown (1)

- | | |
|--|--|
| <ul style="list-style-type: none"> 1 Harmony iPC: Touchscreen display and IIoT Edge Box 2 Modicon TMSES4 smart communication module 3 Modicon M262 Motion controller 4 Modicon TM3 expansion modules (digital, analog, and Expert I/O) 5 TeSys island load management system 6 Lexium 32S servo drives and BMH/BSH servo motors 7 Altivar Machine ATV340S variable speed drives 8 Lexium 28 servo drives and BCH2 servo motors 9 Modicon TM3 Ethernet bus coupler | <ul style="list-style-type: none"> 10 Modicon Ethernet managed switch 11 Modicon TM5CSLC Safety logic controller 12 Modicon TM5: Sercos interface module and I/O modules (digital, analog, and Safety I/O) 13 Encoders 14 Barcode reader 15 Proximity sensors 16 Power meter 17 Harmony® XB5 plastic pushbutton and Emergency stop |
|--|--|



(1) Please refer to our catalogs on [Digi-Cat](#)

+ Ideal for the design service concept

Reduced machine design time (continued)

Industrial Ethernet architecture

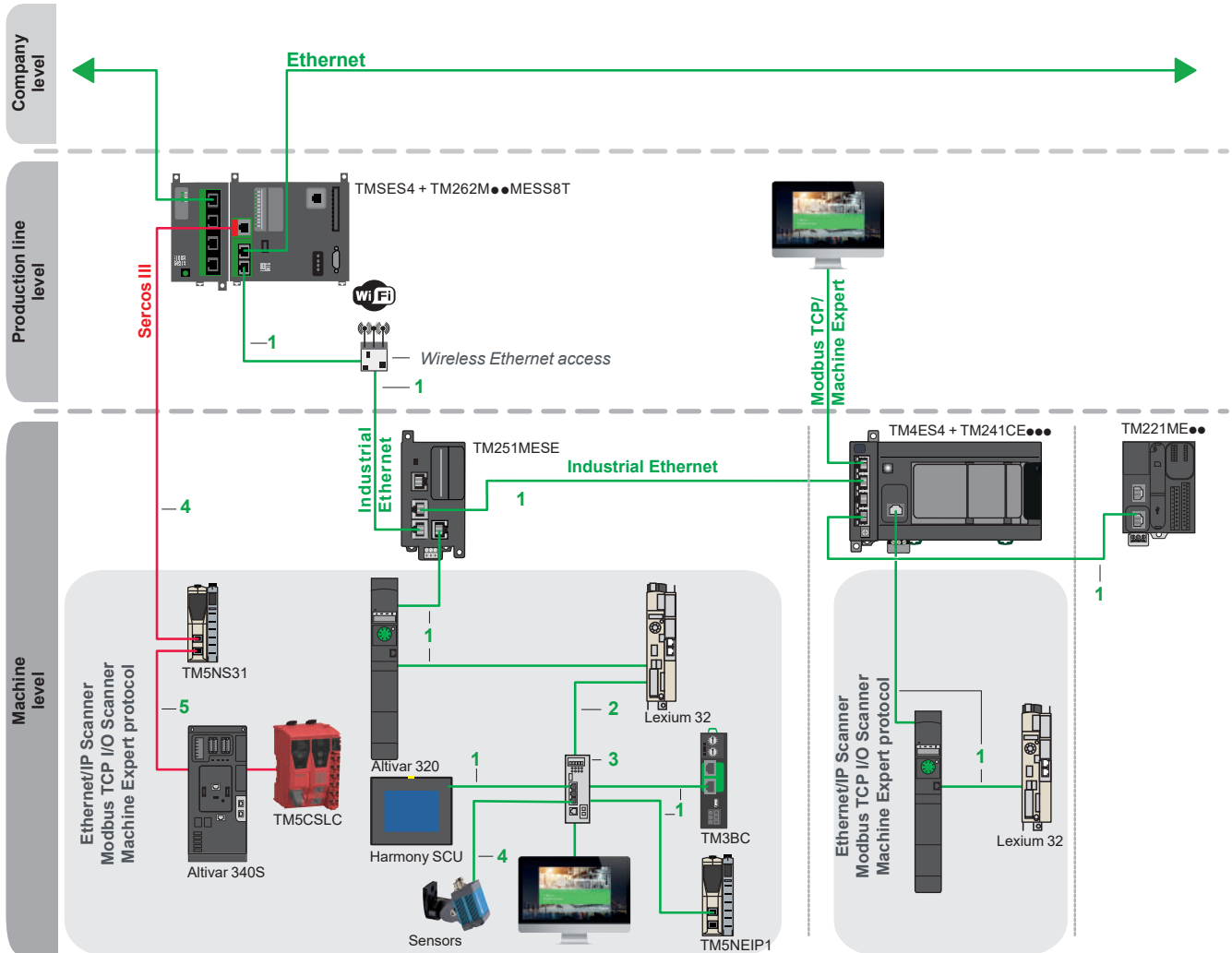

Items 1, 2, 3, 4 and 5: Please refer to [Industrial Ethernet](#) catalog.

Shielded copper connection cables

ConneXium shielded connection cables are available in two versions to meet the various current standards and approvals:

> EIA/TIA 568 shielded twisted pair cables for CE market

These cables conform to:

- EIA/TIA-568 standard, category CAT 5E
- IEC 11801/EN 50173-1 standard, class D

Their fire resistance conforms to:

- NF C32-070 standard, class C2
- IEC 322/1 standards
- Low Smoke Zero Halogen (LSZH)

> EIA/TIA 568 shielded twisted pair cables for UL market

These cables are:

- CEC type FT-1
- NEC type CM

A new range of **ConneXium** fully shielded preformed cordsets has been specially designed for use in harsh industrial environments.

These cordsets combine a category 5E shielded cable and RJ45 connectors reinforced with a metal profile. Please refer to [Modicon Networking](#) catalog and [NEMA Contactors and Starters, Digest Section 16](#) catalog.

+ Accelerate operation efficiency with machine drives



Achilles™ Level 2 certified



Cybersecurity for your assets

Sustained machine operation

Robust design for long-lasting operation and reliable service

ATV340 has been designed to meet the needs of applications for harsh environments such as vibration, shock and non-conductive dust, and where high temperature resistance up to 60 °C/140 °F is needed.

Help to protect people and assets while providing continuity of service

Compliant with machine safety and cybersecurity standards, Altivar Machine ATV340 drives offer an embedded solution that can form part of your enduring protection system for your people and assets.

- > Compliant with machine-related safety standards EN ISO 13849-1 and EN 62061
- > Achilles Level 2 certification against cyber attacks

Fast machine recovery

The Altivar Machine 340 keeps your machine up and running with minimal downtime due to features that include:

- > Fast Device Replacement (FDR) service: With the MachineStruxure architecture in place, device replacement takes just two simple steps by the service technician. Firstly, the pluggable connectors mean a new drive can be fitted in less than 3 minutes, then the drive configuration can be downloaded from the PLC in a single action.
- > Data logging and monitoring by the local system or remote monitoring via the embedded Web server give users access to any motor or application-relevant data anytime, anywhere. This information can be used for predictive maintenance and to avoid breakdowns.

Communication protocol efficiency

Smart design makes the Modicon M262 the IIoT- ready controller for Logic and Motion machines.

- > It offers a real-time automation fieldbus with Sercos for fast motion control, Safety functions, and openness to other devices.
- > One cable simplifies the architecture and fieldbus wiring, allowing EtherNet/IP and Sercos devices to be managed on the same cable.

Modicon M262 Motion controller, optimized local I/O with Modicon TM3



Modicon TM5 Safety logic controller, Modicon TM5 Sercos interface module, Modicon TM5 Safety I/O, Modicon TM7 Safety I/O



Optimized I/O with Modicon TM3: Distributed I/O on Ethernet with TM3 bus coupler



Sercos/EtherNet/IP (up to 6 devices)



Lexium LXM32S



Altivar Machine ATV340S



TeSys Island: connected load management system



Performance I/O with Modicon TM5: Distributed I/O on Ethernet with TM5 interface module

+ Ideal for the design service concept

Variable speed drives

Altivar Machine ATV340

Adaptive Cascade Vector Control



Adaptive Cascade Vector Control

New Motor Control method

ACVC provides better **torque accuracy** and **dynamic response**, it improves dynamic trajectory following and power consumption efficiency.

It enables:

- Improvement of torque limitation
- Precise torque control
- Smooth torque output
- Stable torque performance
- Faster the steady state, regardless the load
- Great torque performance in high speed
- Wider Speed/torque operation range



ACVC is improving all kinds of asynchronous motor applications



3 steps for improvements

New algorithm enhancing the torque control

Mathematical improvement on torque control, motor fluxing and motor nonlinear model (including magnetic saturation).

Tune in Rotation by User commissioning

Enhance electrical control on field weakening and inductance online adaptation.

Cascade control by separated time scales

Different sampling time, optimizing the output performance and access better inductance in function of the rotor flux.

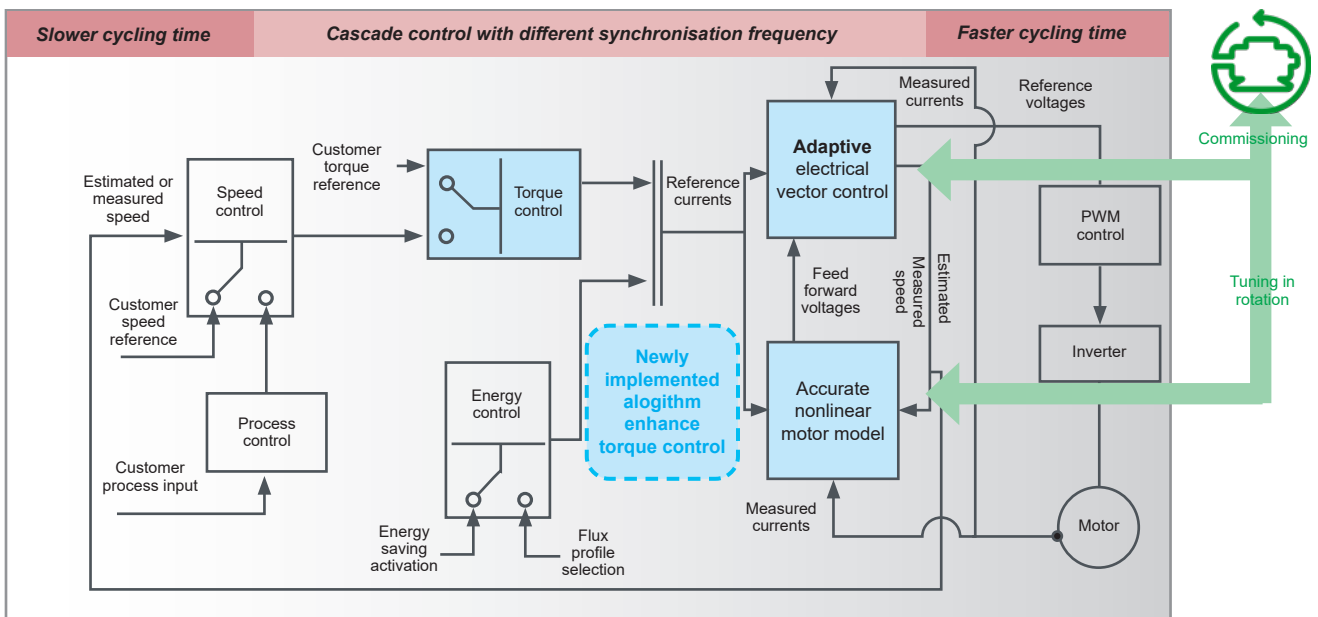

*Control mechanism with patent involved.

Variable speed drives

Altivar Machine ATV340

Adaptive Cascade Vector Control



Graphic display shows the improvement by Torque & Speed curve



Altivar 340 range up to 75 kW



Altivar 900 range from 0.75 kW up to 2.6 MW

Customer values

Torque accuracy

Up to 0.5% of nominal torque error rate and improve 25 percentage points accuracy versus traditional control methods.

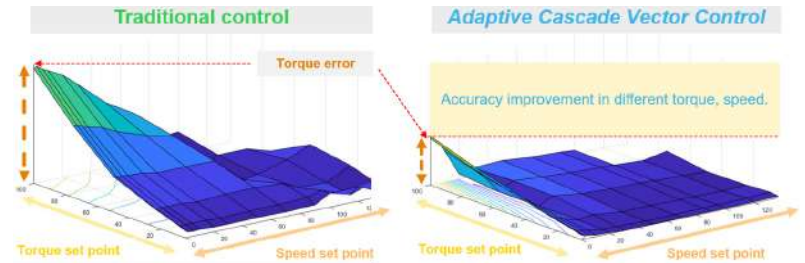

Reduce overall CAPEX and Material Cost :

- Improve manufacturing quality by ~ 5% on final products
- Reduce loss of raw material by ~5% during production
- Reduce installation cost by ~10% by decreasing the amount of additional torque sensor or additional controllers

Reduce overall OPEX and potential Maintenance :

- Less mechanical vibration damage on machines by smooth control and controllable response behavior
- Gain more energy saving by stable output from the motor to mechanical system
- Extend lifetime of mechanical parts, decrease OPEX and service cost

Dynamic Response

Rising time can be lower than 1ms, which is up to 40 % better than traditional control methods. It features:

- Optimized machine dynamic performance, for applications such as Material handling, Material working and crushing process that are requiring faster response.
- Improve manufacturing process efficiency and flexibility, it will be more adaptable within manufacturing process.
- Even in the field-weakening area, it can increase productivity on the machine, no need to increase size of drives and related system.
- Higher speed operational range provide machine builders more possibility.
- It can optimize machines without additional investment, and bring more options for OEM customers in their own product lines.

| | | | | | | |
|----------------------|---------------------|--|--|--|--|--|
| Application segments | General Specific | Material handling, packaging, textiles, hoisting, mechanical actuators, material working Conveyors, carton packers, gantry cranes, woodworking, metal processing, fans, etc. | Packaging, material handling, material working, hoisting Palletizers, shrink wrapping machines, cardboard box folding machines, standard cranes, automatic storage systems, grouping conveyors, slitters, etc. | | | |
|----------------------|---------------------|--|--|--|--|--|



| | | | | | | | |
|---|--|---|--|--|--|--|--|
| Degree of protection | | IP20 | IP20 | IP20 | IP20 | IP20 | IP20 |
| Power range for 50..60 Hz supply | Single-phase 200...240 V | 0.18...2.2 kW/0.25... 3 HP | 0.18...2.2 kW/0.25... 3 HP | – | – | – | – |
| | Three-phase 200...240 V | 0.18...15 kW/0.25...20 HP | – | – | – | – | – |
| | Three-phase 380...480 V | – | – | 0.75...22 kW/1...30 HP | 0.75...22 kW/1...30 HP | 30...75 kW/40...100 HP | 0.75...22 kW/1...30 HP |
| | Three-phase 380...500 V | 0.37...15 kW/0.5...20 HP | 0.37...15 kW/0.5...20 HP | – | – | – | – |
| | Three-phase 525...600 V | 0.75...15 kW/1...20 HP | – | – | – | – | – |
| Drive | Output frequency | 0.1...599 Hz | – | 0.1...599 Hz | – | – | – |
| | Control type | Asynchronous motor Synchronous motor | U/F ratio (2 points, 5 points, energy saving, quadratic), flux vector control without sensor (standard and energy saving) Vector control without sensor | Voltage vector control without sensor, current vector control with sensor, U/F 5 points, energy saving mode | | | Open-loop synchronous motor control (with and without stall monitoring), closed-loop synchronous motor control, synchronous reluctance motor control |
| | Motor sensor | Integrated Available as an option | – RS422 (speed monitoring) | RS422 incremental, Sincos | – | – | RS422 incremental, Sincos |
| | Overload torque performance | Up to 200% Tn of overtorque, and 170% Tn of braking torque for open loop motor control | – | Up to 220% Tn in open loop or closed loop control | – | Up to 180% Tn in open or closed loop control | Up to 220% Tn in open loop or closed loop control |
| Functions | Advanced functions | <ul style="list-style-type: none"> Control of asynchronous and synchronous motors; including IE2, IE3, and PM motors in open loop MachineStruxure integration in EcoStruxure Machine Expert Operation in Velocity mode and Torque control (with current limitation) Customizable and flexible application functions with ATV Logic (up to 50 function blocks) Numerous application functions for targeted application segments Embedded Safety functions dedicated to targeted application segments | <ul style="list-style-type: none"> Control of asynchronous, synchronous, special motors including all efficiency classes, PM motors, torque motors, conical sliding rotor, reluctance Advanced MachineStruxure integration in EcoStruxure Machine Expert Operation in Velocity mode, Torque mode Possibility of adding additional I/O or optional encoder feedback modules Numerous application functions for targeted application segments Very dynamic motor control performance (up to 400 Hz speed bandwidth) and cyclic application task (1 ms) Possibility of Master/Slave daisy chain through PTO/ PTI | <ul style="list-style-type: none"> Integrated EtherNet/IP and Modbus TCP dual port, cybersecurity (Achilles Level 2) Via integrated Web server continuous and real-time application data with customizable dashboards Master/Slave drive-to-drive link via Ethernet | – | – | |
| | Integrated Safety functions | STO (up to SIL3/PLe), SS1, SLS, SMS, GDL | – | STO SIL3/PLe with dual input | – | – | |
| | Number of preset speeds | 16 | – | – | – | – | – |
| Number of integrated I/O | Analog inputs | 3: 1 bipolar differential input ±10 V, 1 voltage input (0...10 V), and 1 current input (0-20 mA) | 2: 1 configurable input (voltage/current/thermal probe) and 1 bipolar differential input ±10 V --- | 3: Configurable as voltage (0...±10 V ---) or current (0-20 mA/4-20 mA), including 2 for probes (PTC, PT100, PT1000, or KTY84) | 2: 1 configurable input (voltage/current/thermal probe) and 1 bipolar differential input ±10 V --- | – | |
| | Digital inputs | 6: 4 configurable inputs (positive or negative logic), 1 input with PTC probe, 1 x 20 kHz pulse input | 5 + 2: 5 configurable inputs (positive or negative logic) and 2 that can be configured as digital input or output | 8: Configurable inputs (positive or negative logic) | 5 + 2: 5 configurable inputs (positive or negative logic) and 2 that can be configured as digital input or output | – | |
| | Analog outputs | 1: Configurable as voltage (0...10 V) or current (0-20 mA) | 1: Configurable as voltage (0...10 V ---) or current (x...20 mA) | 2: Configurable as voltage (0...10 V ---) or current (x...20 mA) | 1: Configurable as voltage (0...10 V ---) or current (x...20 mA) | – | |
| | Digital outputs 3,8 | 1: Configurable as sink or source | 2: Assignable | 1: Assignable | 2: Assignable | – | |
| | Relay outputs | 2: 1 with NO/NC contacts and 1 with NO contacts | 2: 1 with NO/NC contacts and 1 with NO contacts | 3: 1 with NO/NC and 2 with NO contacts | 2: 1 with NO/NC and 1 with NO contacts | – | |
| | Safety function inputs | 1 + 4: 1 with STO and 4 configurable for Safety functions from digital inputs | 2: STO_Ai, STO_Bi for STO Safety function | 2: STO_Ai, STO_Bi for STO Safety function | 2: STO_Ai, STO_Bi for STO Safety function | – | |
| Optional modules | Additional I/O modules | – | Extended I/O module and/or extended relay module | – | – | – | |
| | Safety modules | – | Safety Module Advanced or PROFIsafe Module | Safety Module Advanced or CIP Safety module | Safety Module Advanced or CIP Safety module or PROFIsafe Module | – | |
| Communication | Integrated | Single port compatible with CANopen and Modbus Serial line | 2 ports for Modbus serial line | Dual port for EtherNet/IP and Modbus TCP, 2 ports for Modbus serial line | Dual port for Sercos, 2 ports for Modbus serial line | – | |
| | Optional | EtherNet/IP and Modbus TCP, CANopen RJ45 Daisy Chain, Sub-D, and screw terminals, PROFINET, PROFIBUS DP V1, EtherCAT, DeviceNet, and POWERLINK | CANopen RJ45 Daisy Chain, Sub-D, and screw terminals, PROFINET, PROFIBUS DP V1, EtherCAT, DeviceNet, and POWERLINK | – | CANopen RJ45 Daisy Chain, Sub-D, and screw terminals, PROFINET, PROFIBUS DP V1, EtherCAT, DeviceNet, and POWERLINK | – | |
| Configuration and runtime tools | Integrated display, DTM (Device Type Manager), SoMove software, Simple Loader (optional), Multiloader (optional), and remote graphic terminal (optional) | Status display LEDs, display terminal (optional), DTM (Device Type Manager), SoMove software, EcoStruxure Machine Expert software | Status display LEDs, embedded Web server, display terminal (optional), DTM (Device Type Manager), SoMove software, EcoStruxure Machine Expert software | Status display LEDs, display terminal (optional), SoMove software used with DTM over Modbus Serial line, EcoStruxure Machine Expert software | – | – | |
| Standards and certifications | IEC 61800-5-1, IEC 61800-3 (environments 1 and 2, category C2), UL 508C, EN 954-1 category 3, ISO/EN 13849-1/-2 category 3 (PL e), IEC 61508 (parts 1 & 2) SIL 2 level, draft standard EN 50495E IEC 60721-3-3, classes 3C3 and 3S2 CE, UL, CSA, RCM, EAC, ATEX | UL508C/UL61800-5-1, EN/IEC 61800-3, Environment 1 category C2, EN/IEC 61800-3, Environment 2 category C3, EN/IEC 61800-5-1, IEC 60721-3-3, classes 3C3 and 3S3, IEC 61508, IEC 13849-1, Green Premium, Reach/RoHS | UL508C/UL61800-5-1, EN/IEC 61800-3, Environment 1 category C2, EN/IEC 61800-3, Environment 2 category C3, EN/IEC 61800-5-1, IEC 60721-3-3, classes 3C3 and 3S3, IEC 61508, IEC 13849-1, Green Premium, Reach/RoHS | CE, UL, CSA, TÜV Rheinland, Green Premium, RoHS EU, China | – | – | |
| References | ATV320●●●●●C | ATV320●●●●●B | ATV340●●●●N4 | ATV340●●●●N4E | ATV340●●●●N4E● | ATV340●●●●N4S | |

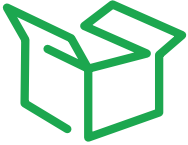

Packaging

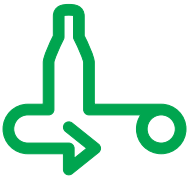

Material handling



Material working



Hoisting



Consumer packaged goods



Textiles



Pumping



General machine control

Machine solution

The Altivar Machine ATV340 is an IP20 high-performance variable speed drive for three-phase synchronous and asynchronous motors in open and closed loop control (1). ATV340 incorporates functions and features suitable for the most common applications, including:

- Packaging
- Material handling
- Material working
- Hoisting
- Consumer packaged goods
- Textiles
- Pumping
- General machine control

Designed to meet the needs of the most demanding automation applications, the Altivar Machine ATV340 achieves high levels of machine performance and throughput. This is combined with simplicity in selection, engineering and design (automation integration), commissioning, machine mass production, and sustained machine operation, including services for machine builders.

The ATV340S, a variable speed drive with a Sercos interface, is designed and tested for a PacDrive system architecture. Typical applications are parcel handling and motion machine architectures.

The ATV340S supports the function "Open loop speed control" as a SercDrive object without license points.

The PacDrive LMC controller generates the motion profile (cyclic position setpoints over Sercos). The Sercos communication module in the ATV340 converts the position into a speed and transmits it to the drive.

The Altivar Machine ATV340 offers realtime automation capabilities, simplified machine engineering, and superior performance for industrial machine applications:

- Dynamic and powerful motor control for asynchronous, synchronous, and reluctance motors
- Drive cycle in real time for the most demanding automation requirements
- Complete integration into any system architecture by offering a native Ethernet product in real time and commonly used industrial communication fieldbuses (CANopen, PROFINET, EtherCAT, etc.). ATV340 Sercos is used in a solution approach, together with the PacDrive Controller LMC Eco or LMC Pro2.
- The drive features and dedicated application functions are the benchmark for high performance requirements
- Safe torque off (STO) with dual inputs compliant with SIL3/PLe to meet machine safety standards
- Data logging, Web server, I/O scanning, easy addressing, and many other services are possible with the Ethernet version, reducing the machine design time and improving machine operation.

The Altivar Machine ATV340 helps enhance machine performance, reduce machine design time, and maintain machine operation, meeting the needs of original equipment manufacturers by pinpointing all the vital stages of the machine lifecycle.

Schneider Electric's MachineStruxure solutions provide abundant ready-to-use, PLCopen-compliant libraries. EcoStruxure Machine Expert can be used to develop, configure, and set up an entire machine in a single software environment. Using FDT/DTM technology, it is possible to configure, control, and diagnose Altivar Machine ATV340 drives directly in EcoStruxure Machine Expert and SoMove software by means of the same software brick (DTM).

EcoStruxure Machine Expert provides verified and documented application libraries for Altivar Machine ATV340 with seamless integration under this platform. Altivar Machine ATV340 has the advantage of reducing engineering and design time for machine builders.

(1) Not supported by Sercos drives.



Packing and packaging machines

Applications

Altivar Machine ATV340 drives embed functions for high-performance machine requirements in the following applications:

Packaging

- Control via built-in Ethernet network (Modbus TCP/IP, SERCOS III) or optional communication networks (EtherNet/IP and Modbus TCP, CANopen, PROFINET, Profibus DP V1, EtherCAT, and DeviceNet)
- Very quick response times on transmission of a command: 1 ms (\pm 0.5 ms)
- Up to 400 Hz speed bandwidth
- Side-by-side mounting to save space inside enclosure
- Advanced synchronous and synchronous reluctance motor open loop control achieves energy saving performance
- Advanced induction and synchronous closed loop control for high-performance motor control



Consumer packaged goods machinery

Consumer packaged goods machinery

- Control via built-in Ethernet network (Modbus TCP/IP, SERCOS III) or optional communication networks (EtherNet/IP and Modbus TCP, CANopen, PROFINET, Profibus DP V1, EtherCAT, and DeviceNet)
 - Very quick response times on transmission of a command: 1 ms (\pm 0.5 ms)
 - Up to 400 Hz speed bandwidth
 - Side-by-side mounting to save space inside enclosure
 - Advanced synchronous and synchronous reluctance motor open loop control achieves energy saving performance
 - Advanced induction and synchronous closed loop control for high-performance motor control
 - Normal duty sizing
 - PID regulator with preset reference
 - Warning monitoring functions
 - Process load monitoring function
 - Separate 24 V for control PCBA board (application function and Safety function).
- In case of power outage on site, the PLC can still retrieve information with the redundant power supply via communication protocols.



Material working

Material working

- Double STO inputs SIL3
- Optional Safety module for operation compliant with applicable safety standards
- Control via built-in Ethernet network (Modbus TCP/IP, SERCOS III) or optional communication networks (EtherNet/IP and Modbus TCP, CANopen, PROFINET, Profibus DP V1, EtherCAT, and DeviceNet)
- Advanced induction and synchronous closed loop control for high-performance motor control
- Embedded encoder input that the user can use as a speed and torque reference
- Fastest possible controlled stop on loss of line supply
- Motor thermal monitoring and protection function
- Torque limitation
- DC sharing and optional compact design regenerative braking unit (ATV regen)
- PTO/PTI functions, achieve 1 to N gearing function depending on setting
- 220% over torque capability, allows a more dynamic response

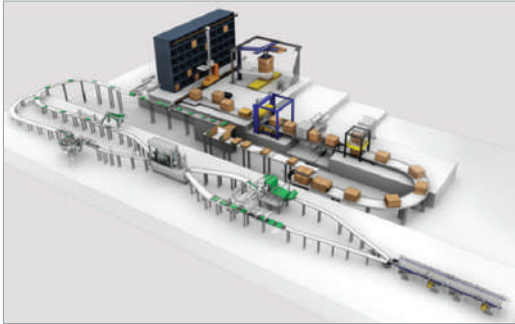

Material handling

Applications (continued)

Material handling

- Very quick response times on transmission of a command: 1 ms (± 0.5 ms)
- Reference via pulse input or analog input as Speed/Torque reference, to adapt hardwired onsite solution
- Control via built-in Ethernet network (Modbus TCP/IP, SERCOS III) or optional communication networks (EtherNet/IP and Modbus TCP, CANopen, PROFINET, Profibus DP V1, EtherCAT, and DeviceNet)
- Position control via limit switches with time optimization at low speed
- Multiple parameter settings via parameter set switching
- Speed and torque master/slave function
- Load sharing
- Advanced induction and synchronous closed loop control for high-performance motor control
- Advanced synchronous and synchronous reluctance motor open loop control achieves energy saving performance
- Separate 24 V for control PCBA board (application function and Safety function). In case of power outage on site, the PLC can still retrieve information with a redundant power supply via communication protocols.



Hoisting

Hoisting

- Control via built-in Ethernet network (Modbus TCP/IP, SERCOS III) or optional communication networks (EtherNet/IP and Modbus TCP, CANopen, PROFINET, Profibus DP V1, EtherCAT, and DeviceNet)
- Brake control adapted for horizontal and vertical movement
- Brake feedback management (for Safety level PLc Cat. 2 compliance)
- Dedicated speed monitoring function with embedded encoder input
- Load measurement using weight sensor
- High-speed hoisting with rope slack
- Load sharing
- Limit switch management
- Multiple motors/configurations
- High speed switching function
- DC sharing and optional compact design regenerative braking unit



Textile application

Textiles

- Control via built-in Ethernet network (Modbus TCP/IP, SERCOS III) or optional communication networks (EtherNet/IP and Modbus TCP, CANopen, PROFINET, Profibus DP V1, EtherCAT, and DeviceNet)
- Double STO inputs, up to SIL3 level
- High resolution of the digital speed reference
- Advanced synchronous and synchronous reluctance open loop control achieves energy saving performance
- Up to 400 Hz speed bandwidth with high-performance speed loop
- DC sharing and optional compact design regenerative braking unit
- Fastest possible controlled stop on loss of line supply
- Side-by-side mounting to save space inside enclosure
- High temperature operating range, up to 60 °C/140 °F
- 3C3 and 3S3 PCBA coating



Pumping

Applications (continued)

Pumping

- Normal duty sizing
- Dedicated motor control law for centrifugal pumps with optimized energy saving
- Advanced synchronous and synchronous reluctance open loop control achieves energy saving performance
- PID regulator with preset reference
- 16 preset speeds
- Multi motor management
- Warning monitoring functions
- Process load monitoring function
- Error detection disable function used in specific situations such as smoke extraction
- STO function for limit pressure emergency
- Communication networks for industry and infrastructure applications
- Separate 24 V for control PCBA board (application function and Safety function). In case of power outage on site, the PLC can still retrieve information with a redundant power supply via communication protocols.



General machine control

General machine control

- Control via built-in Ethernet network (Modbus TCP/IP, SERCOS III) or optional communication networks (EtherNet/IP and Modbus TCP, CANopen, PROFINET, Profibus DP V1, EtherCAT, and DeviceNet)
- Separate 24 V for control PCBA board (application function and Safety function). In case of power outage on site, the PLC can still retrieve information with a redundant power supply via communication protocols.
- PID regulator
- 16 preset speed functions
- +/- speed
- Reference operation
- Line contactor and output contactor control
- Speed or torque control with current/torque limitation
- Speed and torque master/slave function, load sharing
- DC sharing and optional compact design regenerative braking unit
- Embedded encoder input that the user can use as a speed and torque reference
- Advanced motor control laws: V/F 5 points, sensorless vector control, synchronous permanent magnet motor control, synchronous reluctance motor control, and energy saving, allow users to configure different machine behaviors
- Embedded Web server for advanced maintenance (IoT-ready)



ATV340U22N4 (1) ATV340U75N4 (1)



ATV340U22N4E (1) ATV340U75N4E (1) ATV340D22N4E (1)



ATV340U22N4S ATV340U75N4S ATV340D22N4S



ATV340D37N4E (1) ATV340D75N4E (1)

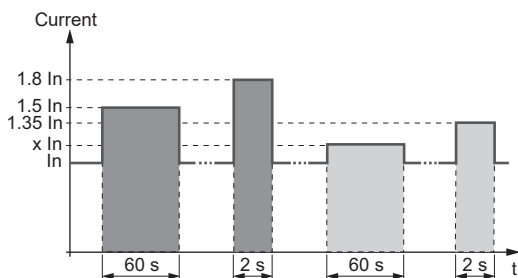

■ Heavy duty operating mode
 □ Normal duty operating mode

Note:
 For ATV340U07...D22N4● drives, $x I_n = 1.1 I_n$
 For ATV340D30...D75N4E drives, $x I_n = 1.2 I_n$
 For ATV340U22...U75N4S drives, $x I_n = 1.1 I_n$

The offer

The Altivar Machine ATV340 range of variable speed drives covers motor power ratings from 0.75 kW/1 HP to 75 kW/100 HP in heavy duty, with 3 product types: Modular, Ethernet and Sercos products:

- 380 V...480 V three-phase, 0.75 kW/1 HP to 22 kW/30 HP covers Modular type (ATV340U07N4 to ATV340D22N4)
- 380 V...480 V three-phase, 0.75 kW/1 HP to 75 kW/100 HP covers Ethernet type (ATV340U07N4E to ATV340D75N4E)
- 380 V...480 V three-phase, 0.75 kW/1 HP to 22 kW/30 HP covers Sercos type (ATV340U07N4S to ATV340D22N4S)

The Modular type is designed to accommodate the majority of commonly-used industrial fieldbus protocols for simple integration in various automation architectures. References ending with "E" indicate the Ethernet version product with multi-protocol Ethernet embedded. The multi-Ethernet protocol consists of EtherNet/IP and Modbus TCP communication interfaces.

All three versions have a book format up to 7.5 kW/10 HP and all sizes can be mounted side by side in order to optimize the machine footprint.

The Altivar Machine ATV340 range is designed to withstand harsh ambient conditions, as references comply with IEC 60721-3-3 Class 3C3 and 3S3 and can operate up to 60 °C/140 °F with derating and 50 °C/122 °F without derating as standard.

The Altivar Machine ATV340 drives integrate Modbus serial line communication protocols as standard. Each device is equipped with 2 RJ45 ports dedicated to:

- Drive connection for configuration software
- Connecting an HMI (keypad) to the drive

In addition, the ATV340 Ethernet drives contain dual RJ45 port multi-Ethernet protocol. The multi-Ethernet protocol integrates EtherNet/IP and Modbus TCP as standard.

The Ethernet drives are able to accommodate 2 slots for option modules serving different purposes.

- GP – SF slot dedicated to optional Safety function module and additional I/O module
- GP – ENC slot designed to take an encoder option module or additional I/O module

Modular drives ATV340U●●N4 are equipped with 3 slots for optional modules, the GP – FB slot being the only difference from the ATV340 Ethernet drive.

- The GP – FB slot can be used for a communication option module to control the drive. ATV340 Modular drives are compatible with the communication interfaces below (see page 39):

- CANopen
- PROFIBUS DP V1
- DeviceNet
- EtherCAT
- PROFINET
- POWERLINK

Heavy duty sizing as standard

Altivar Machine ATV340 drives are sized heavy duty as standard. In the case of lower cycle applications (requiring lower starting current) ATV340 drives can also be sized as normal duty:

- Heavy duty: Dedicated mode for applications requiring significant overload (up to 1.5 In for 60 s and up to 1.8 In (2) for 2 s), the recommended drive selection is standard sizing.
- Normal duty: Dedicated mode for applications requiring slight overload (up to 1.2 In for 60 s and up to 1.35 In for 2 s), the recommended drive selection is one rating lower. For more details please refer to the [ATV340 Installation manual](#).

Torque/Speed accuracy

- Speed accuracy
 - +/- 10% of nominal slip 0.2 Tn to Tn torque variation without speed feedback
 - +/- 0.01% of nominal speed 0.2 Tn to Tn torque variation in closed-loop mode with encoder feedback
- Torque accuracy
 - +/- 10% in open-loop mode, without speed feedback
 - +/- 5% in closed-loop mode with encoder feedback
- Transient overtorque capability
 - 220% of nominal motor torque +/- 10% for 2 s
 - 180% of nominal motor torque +/- 10% for 60 s

(1) Drives are shown with optional plain text display, which can be ordered as an add-on.
 (2) See the selection table on page 22.

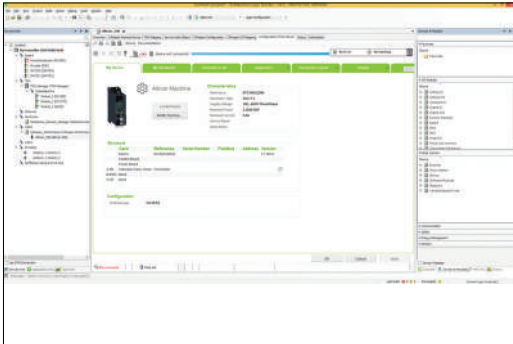

Altivar Machine DTM in EcoStruxure Machine Expert

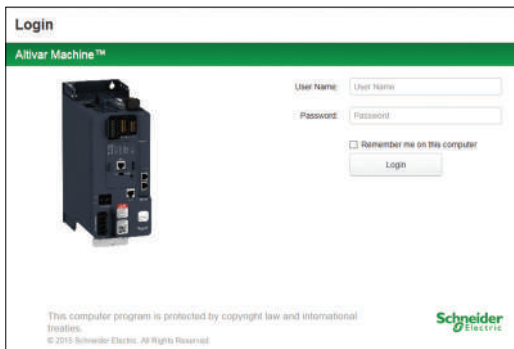

Embedded Web server login screen

Integration

Fieldbus protocols

- EtherNet/IP and Modbus/TCP dual port (1) and Modbus serial link:
 - Standard Modbus and Ethernet protocols
 - Sercos dual port and Modbus serial link
 - Connection of configuration and runtime tools
 - Control of the Altivar Machine ATV340 in automation architectures (PLCs, IPCs, HMIs, etc.) in industrial network protocols for reading/writing data (2):
 - Diagnostic, supervision, and fieldbus management functions
- Ethernet services:
 - SNMP, SNT, BootP & DHCP, IP v6, cybersecurity services, FDR
 - Open Ethernet topologies

Integration of configuration and runtime tools

- FDT/DTM technology (see page 32):
 - Drive configuration, diagnostics, and control using EcoStruxure Machine Expert software with Modicon Machine Solution controllers
 - Drive configuration, diagnostics, and control using EcoStruxure Machine Expert software with PacDrive Machine Solution controllers, for Sercos drive

Dialog and configuration tools

- LED display terminals on front:
 - Monitoring drive status
 - Graphic display terminal (see page 27) (3):
 - Drive control, adjustment, and configuration
 - Display of current values (motor, I/O, etc.)
 - Configuration storage and download
 - Duplication of one drive configuration on another drive from a PC or another drive
 - Connection to several drives using multidrop link components
- Embedded Web server (see page 31) (4):
 - Easily accessible from any PC, iPhone, iPad, Android system, and major Web browsers
 - Network diagnostics in real time
 - Read/write values
- SoMove software (see page 32):
 - Advanced functions for configuration, setup, and maintenance of Altivar Machine drives

Accessories and replacement parts

Accessories

- Display terminal:
 - Plain text display for direct or remote mounting (see page 27)
 - Graphic display terminal for extended mounting (see page 29)
 - Remote mounting kit for mounting on enclosure door (see page 28)
 - Multidrop connection accessories for connecting several drives to the RJ45 terminal port (see page 40)
- Drive-to-drive plus connection accessories (see page 25) (4)
- Flange mounting kit: design for evacuating dissipated heat through the power section by mounting the power part outside an electrical cabinet (see page 25)
- Daisy chain DC bus sharing cable for cost-optimized installations, to create a simple DC bus link (see page 25)

Replacement parts

- Fan kit (see page 25)
- Connector kits for I/O, motor, and power connection (see page 25)

(1) Ethernet devices only.

(2) See previous page for compatible automation fieldbuses in addition to EtherNet/IP and Modbus TCP.

(3) There are 2 possible options for display: mounting on the drive or mounting on the enclosure door using the mounting kit and extension accessories.

(4) Not supported by Sercos drive.



Inserting relay module VW3A3204 into slot GP-SF of the Ethernet ATV340 drive, ATV340U07N4E

Options

- Modules (see [page 37](#)):
 - Encoder modules (see [page 37](#)):
 - Digital interface encoder module 5/12 V
 - Resolver interface module
 - Analog interface encoder module
 - Additional I/O (see [page 38](#)):
 - 2 analog inputs
 - 6 digital inputs
 - 2 digital outputs
 - 3 NO contacts with relay output
 - Safety Modules
 - Safety module Advanced
 - CIP Safety
 - PROFIsafe
 - Communication (see [page 39](#)) (1):
 - CANopen: RJ45 daisy chain, SUB-D, 5-way screw terminals
 - PROFINET
 - Profibus DP V1
 - EtherCAT
 - DeviceNet
 - POWERLINK
- Braking resistors (see [page 49](#))
- Additional EMC input filters for reducing conducted emissions on the AC supply (see [page 51](#))
- Line chokes to reduce the THDi of a system (see [page 53](#))

Motor starters

Schneider Electric offers combinations of circuit breakers and contactors so that Altivar Machine drives can be used in optimum conditions (see [page 59](#)). For prospective line short-circuit currents up to 100 kA, please contact our Customer Care Center.

Standards and certifications

Altivar Machine ATV340 drives have been developed to conform to the international standards and recommendations relating to industrial electrical control devices (IEC), in particular:

- UL508C/UL61800-5-1
- IEC 61800-3:
 - EN/IEC 61800-3, Environments 1 category C2
 - EN/IEC 61800-3, Environments 2 category C3
- EN/IEC 61800-5-1
- IEC 60721-3
- IEC 61508
- IEC 13849-1
- Green Premium, Reach/RoHS

Altivar Machine ATV340 drives are certified:

- UL
- CSA
- TÜV Rheinland
- Green Premium, RoHS EU, China

They are CE marked according to the European low voltage (2014/35/EU) and EMC (2014/30/EU) directives.

(1) Not supported by Sercos drives.

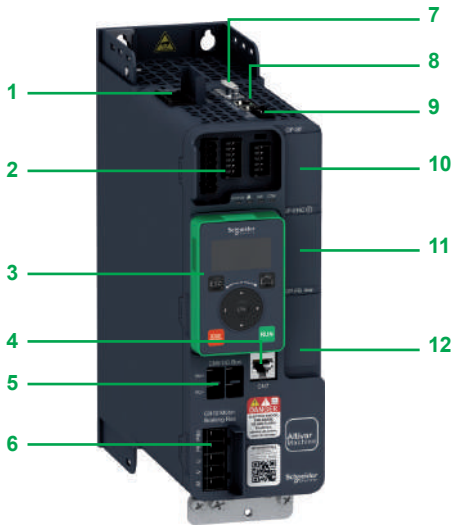

ATV340 Ethernet drive equipped with plain text display terminal

Description

- 1 Power supply terminals
- 2 I/O connection (1):
 - 5 digital inputs:
 - Configurable as positive digital input (source) or negative digital input (sink) compliant with IEC61131-2 PLC standards:
 - 24 V $\overline{\text{---}}$, impedance 4.4 k Ω , sampling time 1 ms +/- 250 μs , response time 1 ms
 - 2 digital inputs or outputs:
 - Configurable and compliant with IEC61131-2 PLC standards
 - 24 V $\overline{\text{---}}$, sampling time 2 ms, maximum voltage 30 V, maximum current 100 mA
 - 2 relay outputs: R1 (3 NO and NC contacts) and R2 (2 NC contacts)
 - R1 - 1 NC contact and 1 NO contact with common point, minimum switching capacity 5 mA for 24 V $\overline{\text{---}}$, maximum switching capacity 3 A on resistive load, 2 A on inductive load for 250 V \sim or 30 V $\overline{\text{---}}$
 - R2 - 1 NC contact, maximum switching capacity 5 A on resistive load
 - 2 analog inputs:
 - 1 configurable (voltage/current/PTC-PT100) analog input, by programming X and Y from 0 to 20 mA
 - 1 bipolar ± 10 V $\overline{\text{---}}$ analog input, sampling time 250 μs
 - 1 analog output, 2 ms +/- 0.5 ms sampling time and 10-bit resolution, configurable as:
 - Voltage analog output 0...10 V $\overline{\text{---}}$, minimum load impedance 470 Ω
 - Current analog output "x to y" mA, maximum load impedance 500 Ω
- 3 Plain text display terminal (can be mounted as an option)
- 4 Modbus Serial line RJ45 port
- 5 DC Bus connection link (2)
- 6 Motor and braking resistor connector
- 7 Encoder feedback interface is compatible with RS422 incremental (A/B/I) and Sin/Cos 1 Vpp (SC) interfaces, 5 V, 12 V, and 24 V supply voltage (3)
- 8 Pulse train output (PTO) and pulse train input (PTI) interface can be used to control the drive via PLC or using hardwired master/slave applications. The interface is equipped with 2 RJ45 ports and the pulse counter can be set at 0...200 kpps (4) (7)
- 9 Safe torque off (STO) dual input SIL3/PLe and 24 V $\overline{\text{---}}$ supply in/out
- 10 GP – SF slot for Safety option module (7) or additional I/O module (see [page 38](#)) (5)
- 11 GP – ENC slot for encoder interface module (see [page 37](#)) or additional I/O module (see [page 38](#))
- 12 GP – FB slot for communication option module (see [page 42](#)) or additional I/O module (see [page 38](#)) (6) or Sercos communication module (8)

(1) ATV340D30N4E to ATV340D75N4E references have 8 digital inputs (positive or negative logic), 1 assignable digital output, 3 analog inputs configurable as voltage or current, including 2 for probes (PTC, PT100, PT1000, or KTY84), 2 analog outputs configurable as voltage (0..10 V) or current (0-20 mA), and 3 relay outputs - 1 with NO/NC and 2 with NO contacts.

(2) ATV340D30N4E to ATV340D75N4E references: DC bus connection is possible but not located on the front of the product; for more details please refer to the [ATV340 Installation manual](#).

(3) ATV340D30N4E to ATV340D75N4E references require an encoder option module for closed loop operation.

(4) ATV340D30N4E to ATV340D75N4E references do not have PTI/PTO for master/slave operation. Drive-to-drive link via Ethernet or analog inputs and outputs can be used.

(5) ATV340D30N4E to ATV340D75N4E references have different option slot positions; for more details please refer to the [ATV340 Installation manual](#).

(6) ATV340●●●N4E references are equipped with dual port EtherNet/IP and Modbus TCP communication, communication option modules can be inserted in ATV340D30N4E...D75N4E references. For more details please refer to the [ATV340 Installation manual](#).

(7) Not supported by Sercos drives.

(8) Sercos drives only.

Variable speed drives

Altivar Machine ATV340

Modular version

Three-phase supply voltage: 380...480 V 50/60 Hz



ATV340U22N4



ATV340U75N4



ATV340D22N4

| Variable speed drives - Modular version (1) | | | | | | | | | | | |
|--|-------------------------------------|-----|-------------------|-------|----------------|----------------------|--------------------------------|-----------------------------------|------------------------------------|---------------------------|--------|
| Motor | AC supply | | | | | | Altivar Machine | | | Reference (1) | Weight |
| | Power indicated on rating plate (2) | | Input current (3) | | Apparent power | Prospective line Isc | Maximum continuous current (2) | Maximum transient current for 2 s | Maximum transient current for 60 s | | |
| HD: Heavy duty (5) | | | 380 V | 480 V | 480 V | | | | | | |
| ND: Normal duty (4) | | | | | | | | | | | |
| | kW | HP | A | A | kVA | kA | A | A | A | kg/lb | |
| Three-phase supply voltage: 380...480 V 50/60 Hz | | | | | | | | | | | |
| HD | 0.75 | 1 | 3.4 | 2.6 | 2.2 | 5 | 2.2 | 4 | 3.3 | ATV340U07N4 1.700/3.748 | |
| ND | 1.1 | 1.5 | 2.6 | 2.1 | 1.7 | 5 | 2.8 | 3.8 | 3.1 | | |
| HD | 1.5 | 2 | 6 | 4.9 | 4.1 | 5 | 4 | 7.2 | 6 | ATV340U15N4 1.700/3.748 | |
| ND | 2.2 | 3 | 5.1 | 4.1 | 3.4 | 5 | 5.6 | 7.6 | 6.2 | | |
| HD | 2.2 | 3 | 8.4 | 6.6 | 5.5 | 5 | 5.6 | 10.1 | 8.4 | ATV340U22N4 1.800/3.968 | |
| ND | 3 | 3 | 6.6 | 5.3 | 4.4 | 5 | 7.2 | 9.7 | 7.9 | | |
| HD | 3 | 3 | 10.7 | 8.5 | 7.1 | 5 | 7.2 | 13 | 10.8 | ATV340U30N4 2.100/4.630 | |
| ND | 4 | 5 | 8.6 | 6.8 | 5.7 | 5 | 9.3 | 12.6 | 10.2 | | |
| HD | 4 | 5 | 13.4 | 10.6 | 8.8 | 5 | 9.3 | 16.7 | 14 | ATV340U40N4 2.200/4.850 | |
| ND | 5.5 | 7 | 11.4 | 9 | 7.5 | 5 | 12.7 | 17.1 | 14 | | |
| HD | 5.5 | 7 | 20 | 16 | 13.3 | 22 | 12.7 | 22.9 | 19.1 | ATV340U55N4 2.900/6.393 | |
| ND | 7.5 | 10 | 15.3 | 12.2 | 10.1 | 22 | 16.5 | 22.3 | 18.2 | | |
| HD | 7.5 | 10 | 25.6 | 20.4 | 17 | 22 | 16.5 | 29.7 | 24.8 | ATV340U75N4 3.000/6.614 | |
| ND | 11 | 15 | 22 | 17.7 | 14.7 | 22 | 24 | 32.4 | 26.4 | | |
| HD | 11 | 15 | 34.7 | 27.7 | 23 | 22 | 24 | 43 | 36 | ATV340D11N4 9.500/20.944 | |
| ND | 15 | 20 | 28.8 | 23 | 19.1 | 22 | 32 | 43 | 35.2 | | |
| HD | 15 | 20 | 44.9 | 35.7 | 29.7 | 22 | 32 | 58 | 48 | ATV340D15N4 9.500/20.944 | |
| ND | 18.5 | 25 | 37.4 | 30.2 | 25.1 | 22 | 39 | 53 | 42.9 | | |
| HD | 18.5 | 25 | 54.7 | 43.4 | 36.1 | 22 | 39 | 70 | 59 | ATV340D18N4 10.200/22.487 | |
| ND | 22 | 30 | 43.4 | 35 | 29.1 | 22 | 46 | 62 | 50.6 | | |
| HD | 22 | 30 | 63.5 | 50.6 | 42.1 | 22 | 46 | 83 | 69 | ATV340D22N4 10.200/22.487 | |
| ND | 30 | 40 | 60.1 | 48.6 | 40.4 | 22 | 62 | 84 | 68.2 | | |

- (1) Altivar Machine **ATV340●●●N4** drives integrate a category C3 EMC filter with 20 m/66 ft shielded motor cable.
- (2) These values are given for a nominal switching frequency of 4 kHz up to **ATV340D22N4**, for use in continuous operation. The switching frequency is adjustable. Above 4 kHz, the drive will automatically reduce the switching frequency in the event of an excessive temperature rise. For continuous operation above the nominal switching frequency, derate the nominal drive current (see derating curves in **ATV340 Installation manual**).
- (3) Typical value for the indicated motor power and for the prospective line Isc.
- (4) For ATV340U07...D22N4● values given for applications requiring slight overload (up to 135% for 2 s and 110% for 60 s).
- (5) For ATV340U07...D22N4● values given for applications requiring significant overload (up to 180% for 2 s and 150% for 60 s).

Note: Drives are shown with optional plain text display, which can be ordered separately as an add-on. Consult the summary tables of possible drive, option, and accessories combinations (see [page 33](#)).

Ambient temperature range:

- For normal duty operation mode: ATV340U07...D22N4 -15...40 °C/5...104 °F without derating (up to 60 °C/140 °F with derating)
 - For heavy duty operation mode: ATV340U07...D22N4 -15...50 °C/5...122 °F without derating (up to 60 °C/140 °F with derating).
- For more details regarding the thermal capacity of references, please visit our website.
- Transportation and storage temperature range for ATV340U07...D22N4 -40...70 °C/-40...158 °F in dry and dust-free environment.

Variable speed drives

Altivar Machine ATV340

Ethernet version

Three-phase supply voltage: 380...480 V 50/60 Hz



ATV340U22N4E



ATV340U75N4E



ATV340D22N4E



ATV340D37N4E

| Variable speed drives - Ethernet version (1) | | | | | | | | | | | |
|---|-------------------------------------|-------------------|-------|----------------|----------------------|--------------------------------|-----------------------------------|------------------------------------|--------|-----------------------------|--------|
| Motor | AC supply | | | | | | Altivar Machine | | | Reference (1) | Weight |
| | Power indicated on rating plate (2) | Input current (3) | | Apparent power | Prospective line Isc | Maximum continuous current (2) | Maximum transient current for 2 s | Maximum transient current for 60 s | | | |
| HD: Heavy duty (5) | 380 V 480 V | | 480 V | | | | | | | | |
| ND: Normal duty (4) | | | | | | | | | | | |
| | kW | HP | A | A | kVA | kA | A | A | A | kg/lb | |
| Three-phase supply voltage: 380...480 V 50/60 Hz | | | | | | | | | | | |
| HD | 0.75 | 1 | 3.4 | 2.6 | 2.2 | 5 | 2.2 | 4 | 3.3 | ATV340U07N4E 1.700/3.748 | |
| ND | 1.1 | 1.5 | 2.6 | 2.1 | 1.7 | 5 | 2.8 | 3.8 | 3.1 | | |
| HD | 1.5 | 2 | 6 | 4.9 | 4.1 | 5 | 4 | 7.2 | 6 | ATV340U15N4E 1.700/3.748 | |
| ND | 2.2 | 3 | 5.1 | 4.1 | 3.4 | 5 | 5.6 | 7.6 | 6.2 | | |
| HD | 2.2 | 3 | 8.4 | 6.6 | 5.5 | 5 | 5.6 | 10.1 | 8.4 | ATV340U22N4E 1.800/3.968 | |
| ND | 3 | 3 | 6.6 | 5.3 | 4.4 | 5 | 7.2 | 9.7 | 7.9 | | |
| HD | 3 | 3 | 10.7 | 8.5 | 7.1 | 5 | 7.2 | 13 | 10.8 | ATV340U30N4E 2.100/4.630 | |
| ND | 4 | 5 | 8.6 | 6.8 | 5.7 | 5 | 9.3 | 12.6 | 10.2 | | |
| HD | 4 | 5 | 13.4 | 10.6 | 8.8 | 5 | 9.3 | 16.7 | 14 | ATV340U40N4E 2.200/4.850 | |
| ND | 5.5 | 7 | 11.4 | 9 | 7.5 | 5 | 12.7 | 17.1 | 14 | | |
| HD | 5.5 | 7 | 20 | 16 | 13.3 | 22 | 12.7 | 22.9 | 19.1 | ATV340U55N4E 2.900/6.393 | |
| ND | 7.5 | 10 | 15.3 | 12.2 | 10.1 | 22 | 16.5 | 22.3 | 18.2 | | |
| HD | 7.5 | 10 | 25.6 | 20.4 | 17 | 22 | 16.5 | 29.7 | 24.8 | ATV340U75N4E 3.000/6.614 | |
| ND | 11 | 15 | 22 | 17.7 | 14.7 | 22 | 24 | 32.4 | 26.4 | | |
| HD | 11 | 15 | 34.7 | 27.7 | 23 | 22 | 24 | 43 | 36 | ATV340D11N4E 9.500/20.944 | |
| ND | 15 | 20 | 28.8 | 23 | 19.1 | 22 | 32 | 43 | 35.2 | | |
| HD | 15 | 20 | 44.9 | 35.7 | 29.7 | 22 | 32 | 58 | 48 | ATV340D15N4E 9.500/20.944 | |
| ND | 18.5 | 25 | 37.4 | 30.2 | 25.1 | 22 | 39 | 53 | 42.9 | | |
| HD | 18.5 | 25 | 54.7 | 43.4 | 36.1 | 22 | 39 | 70 | 59 | ATV340D18N4E 10.200/22.487 | |
| ND | 22 | 30 | 43.4 | 35 | 29.1 | 22 | 46 | 62 | 50.6 | | |
| HD | 22 | 30 | 63.5 | 50.6 | 42.1 | 22 | 46 | 83 | 69 | ATV340D22N4E 10.200/22.487 | |
| ND | 30 | 40 | 60.1 | 48.6 | 40.4 | 22 | 62 | 84 | 68.2 | | |
| HD | 30 | 40 | 54.8 | 48.3 | 40.2 | 50 | 61.5 | 92.25 | 92.25 | ATV340D30N4E 27.900/61.509 | |
| ND | 37 | 50 | 66.2 | 57.3 | 47.6 | 50 | 74.5 | 89.4 | 89.4 | | |
| HD | 37 | 50 | 67.1 | 59 | 49.1 | 50 | 74.5 | 111.75 | 111.75 | ATV340D37N4E 28.400/62.611 | |
| ND | 45 | 60 | 79.8 | 69.1 | 57.4 | 50 | 88 | 105.6 | 105.6 | | |
| HD | 45 | 60 | 81.4 | 71.8 | 59.7 | 50 | 88 | 132 | 132 | ATV340D45N4E 56.400/124.341 | |
| ND | 55 | 75 | 97.2 | 84.2 | 70 | 50 | 106 | 127.2 | 127.2 | | |
| HD | 55 | 75 | 98.9 | 86.9 | 72.2 | 50 | 106 | 159 | 159 | ATV340D55N4E 57.900/127.648 | |
| ND | 75 | 100 | 131.3 | 112.7 | 93.7 | 50 | 145 | 174 | 174 | | |
| HD | 75 | 100 | 134.3 | 118.1 | 98.2 | 50 | 145 | 217.5 | 217.5 | ATV340D75N4E 58.400/128.750 | |
| ND | 90 | 125 | 156.2 | 135.8 | 112.9 | 50 | 173 | 207.6 | 207.6 | | |

- (1) Altivar Machine ATV340U07...D22N4E drives integrate a category C3 EMC filter with 20 m/66 ft shielded motor cable. ATV340D30...D37N4E drives integrate a category C2 EMC filter with 50 m/164 ft motor cable and category C3 EMC filter with 150 m/492 ft motor cable. ATV340D45...D75N4E drives integrate a category C3 EMC filter with 150 m/492 ft shielded motor cable.
- (2) These values are given for a nominal switching frequency of 4 kHz up to **ATV340D37N4E** (2.5 kHz for **ATV340D45N4E...ATV340D75N4E**), for use in continuous operation. The switching frequency is adjustable. Above 2.5 or 4 kHz (depending on the rating), the drive will automatically reduce the switching frequency in the event of an excessive temperature rise. For continuous operation above the nominal switching frequency, derate the nominal drive current (see derating curves in **ATV340 Installation manual**).
- (3) Typical value for the indicated motor power and for the prospective line Isc.
- (4) For ATV340U07...D22N4E values given for applications requiring slight overload (up to 135% for 2 s and 110% for 60 s). For ATV340D30...D75N4E values given for applications requiring slight overload (up to 120% for 60 s).
- (5) For ATV340U07...D22N4E values given for applications requiring significant overload (up to 180% for 2 s and 150% for 60 s). For ATV340D30...D75N4E values given for applications requiring significant overload (up to 150% for 60 s).

Note: Drives are shown with optional plain text display, which can be ordered separately as an add-on. Consult the summary tables of possible drive, option, and accessory combinations (see page 33). Ambient temperature range:

- For normal duty operation mode:
 - ATV340U07...D22N4E -15...40 °C/5...104 °F without derating (up to 60 °C/140 °F with derating)
 - ATV340D30...D75N4E -15...50 °C/5...122 °F without derating (up to 60 °C/140 °F with derating)
 - For heavy duty operation mode:
 - ATV340U07...D22N4E -15...50 °C/5...122 °F without derating (up to 60 °C/140 °F with derating)
 - ATV340D30...D75N4E -15...50 °C/5...122 °F without derating (up to 60 °C/140 °F with derating)
- For more details regarding the thermal capacity of references, please visit [our website](#).
- Transportation and storage temperature range for ATV340U07...D75N4E -40...70 °C/-40...158 °F in dry and dust-free environment.



ATV340D37N4EZ



ATV340D75N4EZ

Variable speed drives - Ethernet version for cabinet integration (1)(6)

| Motor | | AC supply | | | | Altivar Machine | | | | Reference (1) | Weight |
|---|-----------------|-------------------|-------|----------------|----------------------|--------------------------------|-----------------------------------|------------------------------------|--------|---------------|----------------|
| Power indicated on rating plate (2) | | Input current (3) | | Apparent power | Prospective line Isc | Maximum continuous current (2) | Maximum transient current for 2 s | Maximum transient current for 60 s | | | |
| HD: | Heavy duty (5) | 380 V | 480 V | 480 V | kVA | kA | A | A | A | | kg/lb |
| ND: | Normal duty (4) | | | | | | | | | | |
| kW | HP | A | A | kVA | kA | A | A | A | | | |
| Three-phase supply voltage: 380...480 V 50/60 Hz | | | | | | | | | | | |
| HD | 30 | 40 | 54.8 | 48.3 | 40.2 | 50 | 61.5 | 92.25 | 92.25 | ATV340D30N4EZ | 25/ 55.1 |
| ND | 37 | 50 | 66.2 | 57.3 | 47.6 | 50 | 74.5 | 89.4 | 89.4 | | |
| HD | 37 | 50 | 67.1 | 59 | 49.1 | 50 | 74.5 | 111.75 | 111.75 | ATV340D37N4EZ | 26/ 57.3 |
| ND | 45 | 60 | 79.8 | 69.1 | 57.4 | 50 | 88 | 105.6 | 105.6 | | |
| HD | 45 | 60 | 81.4 | 71.8 | 59.7 | 50 | 88 | 132 | 132 | ATV340D45N4EZ | 53.5/ 117.9 |
| ND | 55 | 75 | 97.2 | 84.2 | 70 | 50 | 106 | 127.2 | 127.2 | | |
| HD | 55 | 75 | 98.9 | 86.9 | 72.2 | 50 | 106 | 159 | 159 | ATV340D55N4EZ | 54/ 119 |
| ND | 75 | 100 | 131.3 | 112.7 | 93.7 | 50 | 145 | 174 | 174 | | |
| HD | 75 | 100 | 134.3 | 118.1 | 98.2 | 50 | 145 | 217.5 | 217.5 | ATV340D75N4EZ | 54.5/ 120.1 |
| ND | 90 | 125 | 156.2 | 135.8 | 112.9 | 50 | 173 | 207.6 | 207.6 | | |

(1) ATV340D30...D37N4EZ drives integrate a category C2 EMC filter with 50 m/164 ft motor cable and a category C3 EMC filter with 150 m/492 ft motor cable. Whereas, ATV340D45...D75N4EZ drives integrate a category C3 EMC filter with 150 m/492 ft shielded motor cable.

(2) These values are given for a nominal switching frequency of 4 kHz up to ATV340D37N4EZ (2.5 kHz for ATV340D45N4EZ... ATV340D75N4EZ), for use in continuous operation. The switching frequency is adjustable. Above 2.5 or 4 kHz (depending on the rating), the drive will automatically reduce the switching frequency in the event of an excessive temperature rise. For continuous operation above the nominal switching frequency, derate the nominal drive current (see derating curves in [ATV340 Installation manual](#)).

(3) Typical value for the indicated motor power and for the prospective line Isc.

(4) For ATV340D30...D75N4 values given for applications requiring slight overload (up to 120% for 60 s).

(5) For ATV340D30...D75N4 values given for applications requiring significant overload (up to 150% for 60 s).

(6) These drives are IP00 at the bottom terminals for power connection.

Note: Consult the summary tables of possible drive, option, and accessory combinations (see [page 33](#)).

Ambient temperature range:

■ For normal duty operation mode:

- ATV340D30...D37N4EZ -15...40 °C/5...104 °F without derating (up to 60 °C/140 °F with derating)
- ATV340D45...D75N4EZ -15...50 °C/5...122 °F without derating (up to 60 °C/140 °F with derating)

■ For heavy duty operation mode:

- ATV340D30...D37N4EZ -15...50 °C/5...122 °F without derating (up to 60 °C/140 °F with derating)
- ATV340D45...D75N4EZ -15...50 °C/5...122 °F without derating (up to 60 °C/140 °F with derating)

For more details regarding the thermal capacity of references, please visit [our website](#).

■ Transportation and storage temperature range for ATV340D30...D75N4: -40...70 °C/-40...158 °F in dry and dust-free environment.

Variable speed drives

Altivar Machine ATV340

Sercos version

Three-phase supply voltage: 380...480 V 50/60 Hz



ATV340U22N4S



ATV340U75N4S



ATV340D22N4S

| Variable speed drives - Sercos version (1) | | | | | | | | | | |
|--|-------------------|-------|----------------|----------------------|--------------------------------|-----------------------------------|------------------------------------|------|---------------|----------------------------|
| Motor | AC supply | | | | | Altivar Machine | | | Reference (1) | Weight |
| Power indicated on rating plate (2) | Input current (3) | | Apparent power | Prospective line Isc | Maximum continuous current (2) | Maximum transient current for 2 s | Maximum transient current for 60 s | | | |
| HD: Heavy duty (5) ND: Normal duty (4) | 380 V | 480 V | 480 V | | | | | A | A | A |
| kW | HP | A | A | kVA | kA | A | A | A | kg/lb | |
| Three-phase supply voltage: 380...480 V 50/60 Hz | | | | | | | | | | |
| HD | 0.75 | 1 | 3.4 | 2.6 | 2.2 | 5 | 2.2 | 4 | 3.3 | ATV340U07N4S 1.700/3.748 |
| ND | 1.1 | 1.5 | 2.6 | 2.1 | 1.7 | 5 | 2.8 | 3.8 | 3.1 | |
| HD | 1.5 | 2 | 6 | 4.9 | 4.1 | 5 | 4 | 7.2 | 6 | ATV340U15N4S 1.700/3.748 |
| ND | 2.2 | 3 | 5.1 | 4.1 | 3.4 | 5 | 5.6 | 7.6 | 6.2 | |
| HD | 2.2 | 3 | 8.4 | 6.6 | 5.5 | 5 | 5.6 | 10.1 | 8.4 | ATV340U22N4S 1.800/3.968 |
| ND | 3 | 3 | 6.6 | 5.3 | 4.4 | 5 | 7.2 | 9.7 | 7.9 | |
| HD | 3 | 3 | 10.7 | 8.5 | 7.1 | 5 | 7.2 | 13 | 10.8 | ATV340U30N4S 2.100/4.630 |
| ND | 4 | 5 | 8.6 | 6.8 | 5.7 | 5 | 9.3 | 12.6 | 10.2 | |
| HD | 4 | 5 | 13.4 | 10.6 | 8.8 | 5 | 9.3 | 16.7 | 14 | ATV340U40N4S 2.200/4.850 |
| ND | 5.5 | 7 | 11.4 | 9 | 7.5 | 5 | 12.7 | 17.1 | 14 | |
| HD | 5.5 | 7 | 20 | 16 | 13.3 | 22 | 12.7 | 22.9 | 19.1 | ATV340U55N4S 2.900/6.393 |
| ND | 7.5 | 10 | 15.3 | 12.2 | 10.1 | 22 | 16.5 | 22.3 | 18.2 | |
| HD | 7.5 | 10 | 25.6 | 20.4 | 17 | 22 | 16.5 | 29.7 | 24.8 | ATV340U75N4S 3.000/6.614 |
| ND | 11 | 15 | 22 | 17.7 | 14.7 | 22 | 24 | 32.4 | 26.4 | |
| HD | 11 | 15 | 34.7 | 27.7 | 23 | 22 | 24 | 43 | 36 | ATV340D11N4S 9.500/20.944 |
| ND | 15 | 20 | 28.8 | 23 | 19.1 | 22 | 32 | 43 | 35.2 | |
| HD | 15 | 20 | 44.9 | 35.7 | 29.7 | 22 | 32 | 58 | 48 | ATV340D15N4S 9.500/20.944 |
| ND | 18.5 | 25 | 37.4 | 30.2 | 25.1 | 22 | 39 | 53 | 42.9 | |
| HD | 18.5 | 25 | 54.7 | 43.4 | 36.1 | 22 | 39 | 70 | 59 | ATV340D18N4S 10.200/22.487 |
| ND | 22 | 30 | 43.4 | 35 | 29.1 | 22 | 46 | 62 | 50.6 | |
| HD | 22 | 30 | 63.5 | 50.6 | 42.1 | 22 | 46 | 83 | 69 | ATV340D22N4S 10.200/22.487 |
| ND | 30 | 40 | 60.1 | 48.6 | 40.4 | 22 | 62 | 84 | 68.2 | |

- (1) Altivar Machine ATV340U07...D22N4S drives integrate a category C3 EMC filter with 20 m/66 ft shielded motor cable.
- (2) These values are given for a nominal switching frequency of 4 kHz for use in continuous operation. The switching frequency is adjustable. Above 4 kHz, the drive will automatically reduce the switching frequency in the event of an excessive temperature rise. For continuous operation above the nominal switching frequency, derate the nominal drive current (see derating curves in ATV340 Installation manual).
- (3) Typical value for the indicated motor power and for the prospective line Isc.
- (4) For ATV340U07...D22N4 values given for applications requiring slight overload (up to 135% for 2 s and 110% for 60 s).
- (5) For ATV340U07...D22N4 values given for applications requiring significant overload (up to 180% for 2 s and 150% for 60 s).

Note: Drives are shown with optional plain text display, which can be ordered separately as an add-on. Consult the summary tables of possible drive, option, and accessory combinations (see page 33).
 Ambient temperature range:
 ■ For normal duty operation mode:
 □ ATV340U07...D22N4S -15...40 °C/5...104 °F without derating (up to 60 °C/140 °F with derating)
 ■ For heavy duty operation mode:
 □ ATV340U07...D22N4S -15...50 °C/5...122 °F without derating (up to 60 °C/140 °F with derating)
 For more details regarding the thermal capacity of references, please visit our website.
 ■ Transportation and storage temperature range for ATV340U07...D75N4 -40...70 °C/-40...158 °F in dry and dust-free environment.

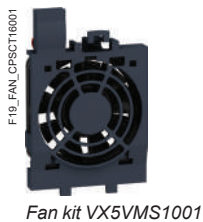
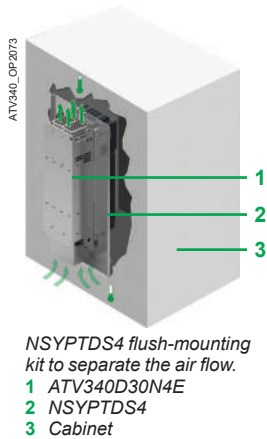
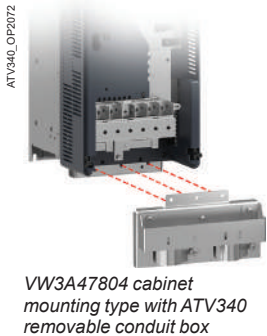

Mounting accessories

| Description | Corresponding drive | Reference | Weight kg/lb |
|--|-------------------------|-----------|-------------------|
| Plate for EMC mounting | ATV340U07N4...U40N4 | VW3A4430 | 0.292/ 0.644 |
| | ATV340U55N4...U75N4 | VW3A4431 | 0.320/ 0.705 |
| | ATV340D11N4...D22N4 | VW3A4432 | 0.423/ 0.933 |
| | ATV340D30N4EZ...D37N4EZ | VW3A47804 | 1.000/ 2.205 |
| | ATV340D45N4EZ...D75N4EZ | VW3A47805 | 1.670/ 3.682 |
| | ATV340D11N4...D22N4 | VW3M2606 | 2.100/ 4.630 |
| Flush-mounting kit for separate air flow For mounting the drive power section outside the enclosure This contains: ■ Fixing accessories ■ 1 metal frame ■ Screws and seals ■ 1 user manual | ATV340D30N4E...D37N4E | NSYPTDS4 | 8.102/ 17.862 |
| | ATV340D45N4E...D75N4E | NSYPTDS5 | 11.086/ 24.440 |

Connection accessories

Daisy chain connection of the DC bus (1)

The DC bus can be connected in a daisy chain in the following cases:

- Drives powered by the AC supply with parallel connection of the DC bus in order to balance the loads during braking phases between the drives; used in addition to braking resistors (see page 49)
- Drives powered by the DC bus only

This requires the connection accessories listed below (2):

| Description | Use between | Length m/ft | Sold in lots of | Reference | Weight kg/lb |
|---|---|---------------|-----------------|--------------|-----------------|
| Cordset (1) equipped with 2 connectors | ATV340U07...U75N4 | 0.18/ 0.59 | 5 | VW3M7101R01 | - |
| | ATV340U07...U75N4E | | | | |
| | ATV340U07...D22N4S | | | | |
| Shielded cable | ATV340U07...U75N4 | 15/ 49 | 1 | VW3M7102R150 | - |
| | ATV340U07...U75N4E | | | | |
| | ATV340U07...D22N4S | | | | |
| Connection kit for VW3M7102R150 cable | - | - | 10 | VW3M2207 | - |
| Daisy chain connection or pulse control | Equipped with 2 RJ45 connectors | 0.3/ 0.98 | 1 | VW3M8502R03 | 0.025/ 0.055 |
| | | 1.5/ 4.92 | 1 | VW3M8502R15 | 0.062/ 0.137 |
| | Equipped with 1 RJ45 connector and a free end | 3/ 9.84 | 1 | VW3M8223R30 | 0.500/ 1.102 |

Replacement parts

| Description | Corresponding drive | Reference | Weight kg/lb |
|--|--|---------------------|--------------|
| Fan kit | | | |
| Power fan for IP21 drives, bracket, instruction sheets | ATV340U07N4...U40N4 | VX5VMS1001 | - |
| | ATV340U55N4...U75N4 | VX5VMS2001 | - |
| | ATV340D11N4...D22N4 | VX5VMS3001 | - |
| | ATV340D30N4E...D37N4E | VX5VPS4001 | - |
| | ATV340D45N4E...D75N4E | VX5VPS5001 | - |
| | Connector kit for I/O, motor, and power connection | ATV340U07N4...U40N4 | VW3A34001 |
| | ATV340U55N4...U75N4 | VW3A34002 | - |
| | ATV340D11N4...D22N4 | VW3A34003 | - |

(1) For more details on DC bus sharing applications, please consult our Customer Care Center.

(2) For more accessories, refer to [Universal Enclosures and Thermal Management](#) catalog.

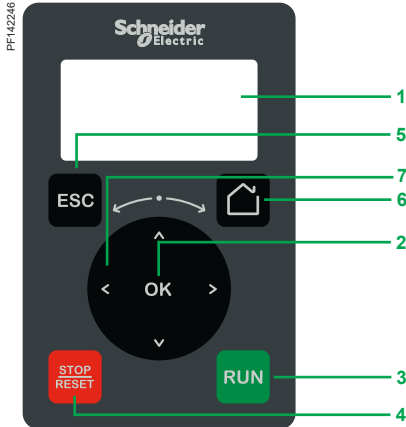

Plain text display terminal

Plain text display terminal

The plain text display terminal can be ordered separately, and can be:

- Connected and mounted on the front of the drive
- Connected and mounted on an enclosure door using a remote-mounting accessory

This terminal is used to:

- Control, adjust, and configure the drive
- Display current values (motor, I/O, and machine data)
- Store and download configurations (several configuration files can be stored in the memory)
- Duplicate the configuration of one powered-up drive on another powered-up drive

Other features:

- Displaying the device - via Web server and password; a display terminal is required to log in to the Web server for the first time
- Realtime clock providing data acquisition and event time-stamping functions
- 2 lines
- Languages (Chinese, English, French, German, Italian, Spanish)
- White backlit LCD screen
- Operating range: -15...50 °C/+5...122 °F
- IP21 protection
- Removable, easy plug-in with RJ45 port

Description

The front of the display terminal comprises:

- 1 LCD backlight screen
- 2 OK button: saves the current value (ENT)
- 3 RUN button: local control of motor run command
- 4 STOP/RESET button: local control of motor stop command/clearing detected errors
- 5 ESC button: aborts a value, parameter, or menu to return to the previous selection
- 6 Home: root menu
- 7 Turn ±: navigation dial, increases or decreases the value, goes to the next or previous line

References

| Description | Reference | Weight kg/ lb |
|-----------------------------|-----------|---------------------|
| Plain text display terminal | VW3A1113 | 0.200/ 0.441 |



Remote-mounting kit for mounting plain text display terminal on enclosure door (front panel)

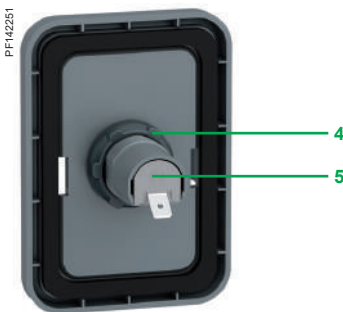

Remote-mounting kit for mounting plain text display terminal on enclosure door (rear panel)

Mounting kit for plain text display terminal

- Remote-mounting kit for mounting on an enclosure door with IP43 degree of protection as standard

Description

The kit comprises:

- Tightening tool (also sold separately under the reference ZB5AZ905)

- 1 Mounting plate
- 2 RJ45 port for the plain text display terminal
- 3 Seal
- 4 Fixing nut
- 5 RJ45 port for connecting the remote-mounting cordset

Cordsets should be ordered separately depending on the length required.

Drilling a hole with a standard $\varnothing 22$ tool, as used for a pushbutton, allows the unit to be mounted without the need for a cut-out in the enclosure ($\varnothing 22.5$ mm/ $\varnothing 0.89$ in. drill hole).

An anti-rotation function is provided that works as follows: when the kit is locked tightly onto the panel by the nut, the gasket on the back cannot rotate.

References

| Description | Length m/ ft | IP degree of protection | Reference | Weight kg/ lb |
|--|--------------------|----------------------------|------------------------------|---------------------|
| Remote-mounting kit Order with remote-mounting cordset VW3A1104R●●● | – | 43 | VW3A1114 | – |
| Tightening tool for remote-mounting kit | – | – | ZB5AZ905 | 0.016/ 0.035 |
| Remote-mounting cordset equipped with 2 RJ45 connectors | 1/ 3.28 | – | VW3A1104R10 | 0.050/ 0.110 |
| | 3/ 9.84 | – | VW3A1104R30 | 0.150/ 0.331 |
| | 5/ 16.4 | – | VW3A1104R50 | 0.250/ 0.551 |
| | 10/ 32.8 | – | VW3A1104R100 | 0.500/ 1.102 |



Graphic display terminal
VW3A1111



Detected fault: The screen's red backlight is activated automatically



Example of multipoint screen architecture



Embedded dynamic QR codes for contextual, instantaneous access to online help



Scanning the QR code from a smartphone or tablet



Instant access to online help

Graphic display terminal

This terminal can be:

- Connected and mounted on an enclosure door using a remote-mounting accessory
- Connected to a PC to exchange files via a Mini USB/USB connection (1)
- Connected to several drives in multipoint mode

This terminal is used to:

- Control, adjust, and configure the drive
- Display current values (motor, I/O, and machine data)
- Display graphic dashboards such as the energy consumption monitoring dashboard
- Store and download configurations (several configuration files can be stored in the 16 MB memory)
- Duplicate the configuration of one powered-up drive on another powered-up drive
- Copy configurations from a PC or drive and duplicate them on another drive (the drives should be powered up throughout the duplication operations)

Other characteristics:

- Up to 24 languages (complete alphabets) covering the majority of countries around the world (languages can be removed, added and updated according to user needs; please consult [our website](#))
- 2-color backlit display (white and red); if an error is detected, the red backlight is activated automatically (function can be disabled)
- Operating range: -15...50 °C/+5...122 °F
- Degree of protection: IP65
- Trend curves: Graphic display of changes over time in monitoring variables, energy data, and machine data
- Realtime clock with 10-year backup battery providing data acquisition and event time-stamping functions even when the drive is stopped

Multipoint screen

The graphic display terminal is connected to one drive only. However, communication is possible between a graphic display terminal and several Altivar drives (ATV340, ATV600, and ATV900) connected on the same Modbus serial fieldbus via the RJ45 port (HMI or Modbus serial). In this case, multipoint mode is automatically applied to the graphic display terminal.

A maximum of 32 drives can be connected on the same Modbus serial fieldbus.

Apart from the Stop function linked to the STOP/RESET key, multipoint mode cannot be used to apply a reset after a fault has been detected or control the drive via the graphic display terminal: in multipoint mode, the Run key and the Local/Remote key are disabled.

Description

Display:

- 8 lines, 240 x 160 pixels
- Displays bar charts, gages, and trend charts
- 4 function keys to facilitate navigation and provide contextual links for enabling functions
- STOP/RESET button: Local control of motor stop command/clearing detected errors
- RUN button: Local control of motor run command
- Navigation buttons:
 - OK button: Saves the current value (ENT)
 - Turn ±: Increases or decreases the value, goes to the next or previous line
 - ESC button: Aborts a value, parameter, or menu to return to the previous selection
 - Home: Root menu
 - Information (i): Contextual help

References

| Description | Reference | Weight kg/ lb |
|--------------------------|-----------|---------------------|
| Graphic display terminal | VW3A1111 | 0.200/ 0.441 |

(1) Graphic display terminal used only as a handheld terminal.

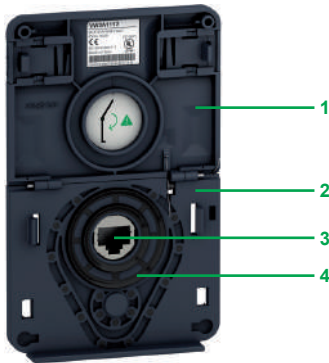

Remote-mounting kit for mounting graphic display terminal on enclosure door (front panel)

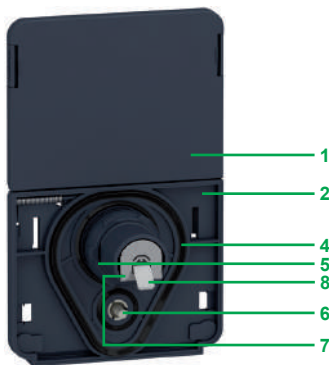

Remote-mounting kit for graphic display terminal (rear panel)

Accessories for graphic display terminal

- Remote-mounting kit for mounting on enclosure door with IP65/UL Type 12 degree of protection as standard

The kit comprises:

- Tightening tool (also sold separately under the reference ZB5AZ905)

- Cover plate to maintain IP65 protection when there is no terminal connected
- Mounting plate
- RJ45 port for the graphic display terminal
- Seal
- Fixing nut
- Anti-rotation pin
- RJ45 port for connecting the remote-mounting cordset (10 m/32.8 ft maximum)
Cordsets should be ordered separately depending on the length required.
- Grounding connector

Drilling a hole with a standard $\varnothing 22$ tool, as used for a pushbutton, allows the unit to be mounted without the need for a cut-out in the enclosure ($\varnothing 22.5$ mm/ $\varnothing 0.89$ in. drill hole).

References

| Description | Length m/ ft | IP | Reference | Weight kg/ lb |
|--|--------------------|------------------|------------------------------|---------------------|
| Remote-mounting kit Order with remote-mounting cordset VW3A1104R●●● | – | 65/UL Type 12 | VW3A1112 | – |
| Tightening tool for remote-mounting kit | – | – | ZB5AZ905 | 0.016/ 0.035 |
| Remote-mounting cordset equipped with 2 RJ45 connectors | 1/ 3.28 | – | VW3A1104R10 | 0.050/ 0.110 |
| | 3/ 9.84 | – | VW3A1104R30 | 0.150/ 0.331 |
| | 5/ 16.4 | – | VW3A1104R50 | 0.250/ 0.551 |
| | 10/ 32.8 | – | VW3A1104R100 | 0.500/ 1.102 |
| | – | 65 | VW3A1115 | 0.200/ 0.441 |
| IP65 remote-mounting kit for Ethernet port (1) $\varnothing 22$ RJ45 female/female adapter with seal | – | 65 | VW3A1115 | 0.200/ 0.441 |

Configuration tools

Connection accessories

| Description | Reference | Weight kg/ lb |
|--|-------------------------------|---------------------|
| SoMove setup software For configuring, adjusting, and debugging the Altivar Machine drive | (2) | – |
| USB/RJ45 cable equipped with a USB connector and an RJ45 connector. For connecting a PC to the drive. Length: 2.5 m/8.2 ft | TCSCNAM3M002P | – |

Communication accessories

| Description | Reference | Weight kg/ lb |
|---|-----------------------------|---------------------|
| Universal IP20 WiFi interface Remote mounting of the Ethernet port for connecting WiFi equipment (PC, tablet, smartphone, etc.) powered by internal rechargeable battery RJ45 and micro USB connectors | TCSEGWB131W | 0.255/ 0.562 |

(1) Used to connect a remote PC to the RJ45 port on an IP21 drive mounted in an enclosure or on a wall. Drill hole with a standard $\varnothing 22$ tool, as used for a pushbutton. (Requires remote-mounting cordset VW3A1104R●●● equipped with 2 RJ45 connectors).

(2) See [page 32](#).

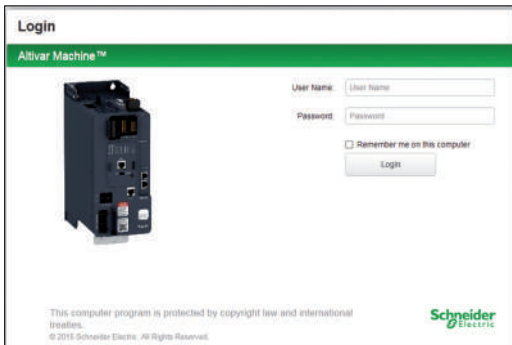

Login screen

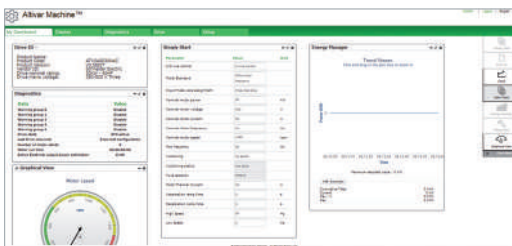

Customizable widgets



Drive parameters tab



Energy dashboard

Web server

Presentation

- The Web server can only be accessed via an Ethernet-embedded drive ATV340●●●N4E
- Connection of a drive that is not a part of an Ethernet network
 - Wired connection via an Ethernet cable using the drive Ethernet port
 - Wireless connection via Schneider Electric WiFi dongle
- Connection of a drive that is part of an Ethernet network
 - From any point on the network by entering the drive IP address
- The Web server is used for:
 - Commissioning the drive (setting configuration parameters and enabling the main functions)
 - Monitoring energy and machine data, as well as drive and motor data
 - Diagnostics (drive status, file transfer, detected error and warning logs)

Description

The Web server is structured around five tabs.

- "My dashboard" tab:
 - Configurable using a wide range of widgets; groups the information and dashboards selected by the user together on one page
 - Graphics, charts, and monitoring tables can be customized to provide a user-friendly interface
- "Display" tab:
 - Monitors energy indicators, efficiency, and performance
 - Displays time-stamped application data such as motor current or temperature
 - Monitors drive parameters and status
 - Shows the I/O state and assignment
- "Diagnostics" tab:
 - Drive status
 - Time and date-stamped warning and detected error logs
 - Network diagnostics
 - Access to drive self-tests
- "Drive" tab:
 - Viewing the main drive parameters
 - Editing the main drive parameters
- "Setup" tab:
 - Network configuration
 - Access management
 - Transferring and retrieving drive configurations
 - Exporting data acquisition files and logs
 - Customizing pages (colors, logos, etc.)

Other characteristics:

- Ease of connection via the RJ45 port or WiFi connection
- Password-protected authentication (modifiable password; access rights can be configured by administrator)
- No specific tool required or installation necessary, just connect to the Web browser from a drive (using standard Ethernet cable or WiFi dongle)
- Web server can be disabled
- Works in a similar way on PCs, iPhones, iPads, Android systems, and the major Web browsers:
 - Internet Explorer® (version 8 or higher)
 - Google Chrome® (version 11 or higher)
 - Mozilla Firefox® (version 4 or higher)
 - Safari® (version 5.1.7 or higher)

DTM

Presentation

Using FDT/DTM technology it is possible to configure, control, and diagnose Altivar Machine drives directly in EcoStruxure Machine Expert and SoMove software by means of the same software brick (DTM).

FDT/DTM technology standardizes the communication interface between field devices and host systems. The DTM contains a uniform structure for managing drive access parameters.

Specific functions of the Altivar Machine DTM

- Offline or online access to drive data
- Transferring configuration files from and to the drive
- Customization (dashboard, My Menu, etc.)
- Access to drive parameters and option cards
- Oscilloscope function
- Energy and application data dashboards
- Detected error and warning logs (with time-stamping)
- Configuration, transfer, and monitoring of the Safety functions

Advantages of the DTM in EcoStruxure Machine Expert:

- Single tool for configuration, setup, and diagnostics
- Network scan for automatic recognition of network configuration in Ethernet architectures (1)
- Ability to add/remove, copy/paste configuration files from other drives in the same architecture
- Single input point for all parameters shared between the PLC (programmable logic controller) and the Altivar Machine drives
- Creation of drive profiles for implicit communication with the PLC as well as dedicated profiles for programs with DFBs (derived function blocks)
- Integration in the fieldbus topology
- Drive configuration is an integral part of the EcoStruxure Machine Expert project file
- Application function block for EcoStruxure Machine Expert PLC
- Display visualization blocks for Vijeo Designer

Advantages of the DTM in SoMove:

- Drive-oriented software environment
- Wired connection to the Ethernet communication port
- Standard cable (file transfer performance)

■ Third-party software and downloads:

The Altivar Machine ATV340 DTM is a flexible, open, and interactive tool that can be used in a third-party FDT.

DTM Library can be downloaded from [our website](#).

SoMove software

Presentation

SoMove software for PC is used to configure, set up, and maintain Altivar Machine drives.

In addition to the functions offered by the Web server, SoMove software features the oscilloscope function for accurate display of data samples, as well as access to multi-drive applications.

The software can be connected to Altivar Machine ATV340 variable speed drives via:

- A direct USB/RJ45 cable (Modbus serial) link
- Ethernet Modbus and WiFi connection with the WiFi dongle **TCSEGWB131W**
- Ethernet Modbus TCP connection

For ATV340 Sercos drives, DTM is used with SoMove over Modbus Serial line only. For more information on SoMove setup software, please refer to the [SoMove: Setup Software](#) catalog.

(1) Only applicable for ATV340 Ethernet drives, ATV340●●●N4E.



Altivar Machine DTM in EcoStruxure Machine Expert



SoMove software

Safety function transfer and configuration

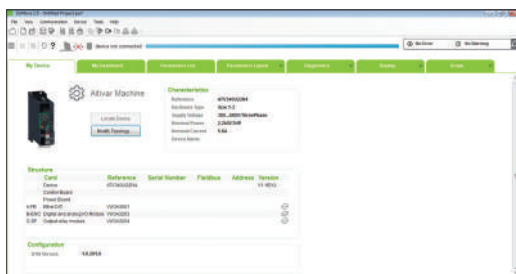

Altivar Machine in SoMove



SoMove software

General presentation:
[page 4](#)

Drives:
[page 18](#)

Motor starters:
[page 59](#)



Dimensions:
[page 61](#)

Service:
[page 66](#)

| Combinations of options for Altivar Machine 340 drives | | | | | | | | | | | | | |
|--|-----|-------------|-----|---------------|-------------|---------------------------------|-------------------|--------------|--------------|----------------|----------------------|-------------------|-------------------|
| Motor | | Motor | | Drive | Accessories | | Options | | | Line AC chokes | dv/dt output filters | EMC input filters | Regenerative unit |
| Heavy duty | | Normal duty | | | EMC kit | Push-through flush mounting kit | Braking resistors | | | | | | |
| kW | HP | kW | HP | | | | Light cycle | Medium cycle | Severe cycle | | | | |
| Three-phase supply voltage: 380...480 V 50/60 Hz - Modular drive | | | | | | | | | | | | | |
| 0.75 | 1 | 1.1 | 1.5 | ATV340U07N4 | VW3A4430 | – | VW3A7730 | VW3A7740 | VW3A7750 | VW3A4551 | VW3A5301 | VW3A4422 | ATVRU75N4 |
| 1.5 | 2 | 2.2 | 3 | ATV340U15N4 | VW3A4430 | – | VW3A7730 | VW3A7740 | VW3A7750 | VW3A4551 | VW3A5301 | VW3A4422 | ATVRU75N4 |
| 2.2 | 3 | 3 | 3 | ATV340U22N4 | VW3A4430 | – | VW3A7730 | VW3A7740 | VW3A7750 | VW3A4552 | VW3A5302 | VW3A4423 | ATVRU75N4 |
| 3 | 3 | 4 | 5 | ATV340U30N4 | VW3A4430 | – | VW3A7730 | VW3A7740 | VW3A7750 | VW3A4552 | VW3A5302 | VW3A4423 | ATVRU75N4 |
| 4 | 5 | 5.5 | 7 | ATV340U40N4 | VW3A4430 | – | VW3A7731 | VW3A7741 | VW3A7751 | VW3A4552 | VW3A5302 | VW3A4423 | ATVRU75N4 |
| 5.5 | 7 | 7.5 | 10 | ATV340U55N4 | VW3A4431 | – | VW3A7731 | VW3A7741 | VW3A7751 | VW3A4553 | VW3A5303 | VW3A4423 | ATVRU75N4 |
| 7.5 | 10 | 11 | 15 | ATV340U75N4 | VW3A4431 | – | VW3A7732 | VW3A7742 | VW3A7752 | VW3A4553 | VW3A5303 | VW3A4423 | ATVRU75N4 |
| 11 | 15 | 15 | 20 | ATV340D11N4 | VW3A4432 | VW3M2606 | VW3A7732 | VW3A7742 | VW3A7752 | VW3A4554 | VW3A5304 | VW3A4711 | ATVRD15N4 |
| 15 | 20 | 18.5 | 25 | ATV340D15N4 | VW3A4432 | VW3M2606 | VW3A7733 | VW3A7743 | VW3A7753 | VW3A4554 | VW3A5304 | VW3A4711 | ATVRD15N4 |
| 18 | 25 | 22 | 30 | ATV340D18N4 | VW3A4432 | VW3M2606 | VW3A7733 | VW3A7743 | VW3A7753 | VW3A4555 | VW3A5304 | VW3A4712 | ATVRD15N4 |
| 22 | 30 | 30 | 40 | ATV340D22N4 | VW3A4432 | VW3M2606 | VW3A7733 | VW3A7743 | VW3A7753 | VW3A4555 | VW3A5305 | VW3A4712 | ATVRD15N4 |
| Three-phase supply voltage: 380...480 V 50/60 Hz - Ethernet drive | | | | | | | | | | | | | |
| 0.75 | 1 | 1.1 | 1.5 | ATV340U07N4E | VW3A4430 | – | VW3A7730 | VW3A7740 | VW3A7750 | VW3A4551 | VW3A5301 | VW3A4422 | ATVRU75N4 |
| 1.5 | 2 | 2.2 | 3 | ATV340U15N4E | VW3A4430 | – | VW3A7730 | VW3A7740 | VW3A7750 | VW3A4551 | VW3A5301 | VW3A4422 | ATVRU75N4 |
| 2.2 | 3 | 3 | 3 | ATV340U22N4E | VW3A4430 | – | VW3A7730 | VW3A7740 | VW3A7750 | VW3A4552 | VW3A5302 | VW3A4423 | ATVRU75N4 |
| 3 | 3 | 4 | 5 | ATV340U30N4E | VW3A4430 | – | VW3A7730 | VW3A7740 | VW3A7750 | VW3A4552 | VW3A5302 | VW3A4423 | ATVRU75N4 |
| 4 | 5 | 5.5 | 7 | ATV340U40N4E | VW3A4430 | – | VW3A7731 | VW3A7741 | VW3A7751 | VW3A4552 | VW3A5302 | VW3A4423 | ATVRU75N4 |
| 5.5 | 7 | 7.5 | 10 | ATV340U55N4E | VW3A4431 | – | VW3A7731 | VW3A7741 | VW3A7751 | VW3A4553 | VW3A5303 | VW3A4423 | ATVRU75N4 |
| 7.5 | 10 | 11 | 15 | ATV340U75N4E | VW3A4431 | – | VW3A7732 | VW3A7742 | VW3A7752 | VW3A4553 | VW3A5303 | VW3A4423 | ATVRU75N4 |
| 11 | 15 | 15 | 20 | ATV340D11N4E | VW3A4432 | VW3M2606 | VW3A7732 | VW3A7742 | VW3A7752 | VW3A4554 | VW3A5304 | VW3A4711 | ATVRD15N4 |
| 15 | 20 | 18.5 | 25 | ATV340D15N4E | VW3A4432 | VW3M2606 | VW3A7733 | VW3A7743 | VW3A7753 | VW3A4554 | VW3A5304 | VW3A4711 | ATVRD15N4 |
| 18 | 25 | 22 | 30 | ATV340D18N4E | VW3A4432 | VW3M2606 | VW3A7733 | VW3A7743 | VW3A7753 | VW3A4555 | VW3A5304 | VW3A4712 | ATVRD15N4 |
| 22 | 30 | 30 | 40 | ATV340D22N4E | VW3A4432 | VW3M2606 | VW3A7733 | VW3A7743 | VW3A7753 | VW3A4555 | VW3A5305 | VW3A4712 | ATVRD15N4 |
| 30 | 40 | 37 | 50 | ATV340D30N4E | – | NSYPTDS4 | VW3A7734 | VW3A7744 | VW3A7754 | – | VW3A5305 | VW3A4706 | ATVRD15N4 |
| 37 | 50 | 45 | 60 | ATV340D37N4E | – | NSYPTDS4 | VW3A7734 | VW3A7744 | VW3A7754 | – | VW3A5305 | VW3A4706 | ATVRD15N4 |
| 45 | 60 | 55 | 75 | ATV340D45N4E | – | NSYPTDS5 | VW3A7735 | VW3A7745 | VW3A7755 | – | VW3A5306 | VW3A4707 | ATVRD15N4 |
| 55 | 75 | 75 | 100 | ATV340D55N4E | – | NSYPTDS5 | VW3A7736 | VW3A7746 | VW3A7756 | – | VW3A5306 | VW3A4708 | ATVRD15N4 |
| 75 | 100 | 90 | 125 | ATV340D75N4E | – | NSYPTDS5 | VW3A7736 | VW3A7746 | VW3A7756 | – | VW3A5306 | VW3A4708 | ATVRD15N4 |
| Three-phase supply voltage: 380...480 V 50/60 Hz - Ethernet drive for cabinet integration | | | | | | | | | | | | | |
| 30 | 40 | 37 | 50 | ATV340D30N4EZ | VW3A47804 | – | VW3A7734 | VW3A7744 | VW3A7754 | – | VW3A5305 | VW3A4706 | ATVRD15N4 |
| 37 | 50 | 45 | 60 | ATV340D37N4EZ | VW3A47804 | – | VW3A7734 | VW3A7744 | VW3A7754 | – | VW3A5305 | VW3A4706 | ATVRD15N4 |
| 45 | 60 | 55 | 75 | ATV340D45N4EZ | VW3A47805 | – | VW3A7735 | VW3A7745 | VW3A7755 | – | VW3A5306 | VW3A4707 | ATVRD15N4 |
| 55 | 75 | 75 | 100 | ATV340D55N4EZ | VW3A47805 | – | VW3A7736 | VW3A7746 | VW3A7756 | – | VW3A5306 | VW3A4708 | ATVRD15N4 |
| 75 | 100 | 90 | 125 | ATV340D75N4EZ | VW3A47805 | – | VW3A7736 | VW3A7746 | VW3A7756 | – | VW3A5306 | VW3A4708 | ATVRD15N4 |
| Three-phase supply voltage: 380...480 V 50/60 Hz - Sercos drive | | | | | | | | | | | | | |
| 0.75 | 1 | 1.1 | 1.5 | ATV340U07N4S | VW3A4430 | – | VW3A7730 | VW3A7740 | VW3A7750 | VW3A4551 | VW3A5301 | VW3A4422 | ATVRU75N4 |
| 1.5 | 2 | 2.2 | 3 | ATV340U15N4S | VW3A4430 | – | VW3A7730 | VW3A7740 | VW3A7750 | VW3A4551 | VW3A5301 | VW3A4422 | ATVRU75N4 |
| 2.2 | 3 | 3 | 3 | ATV340U22N4S | VW3A4430 | – | VW3A7730 | VW3A7740 | VW3A7750 | VW3A4552 | VW3A5302 | VW3A4423 | ATVRU75N4 |
| 3 | 3 | 4 | 5 | ATV340U30N4S | VW3A4430 | – | VW3A7730 | VW3A7740 | VW3A7750 | VW3A4552 | VW3A5302 | VW3A4423 | ATVRU75N4 |
| 4 | 5 | 5.5 | 7 | ATV340U40N4S | VW3A4430 | – | VW3A7731 | VW3A7741 | VW3A7751 | VW3A4552 | VW3A5302 | VW3A4423 | ATVRU75N4 |
| 5.5 | 7 | 7.5 | 10 | ATV340U55N4S | VW3A4431 | – | VW3A7731 | VW3A7741 | VW3A7751 | VW3A4553 | VW3A5303 | VW3A4423 | ATVRU75N4 |
| 7.5 | 10 | 11 | 15 | ATV340U75N4S | VW3A4431 | – | VW3A7732 | VW3A7742 | VW3A7752 | VW3A4553 | VW3A5303 | VW3A4423 | ATVRU75N4 |
| 11 | 15 | 15 | 20 | ATV340D11N4S | VW3A4432 | VW3M2606 | VW3A7732 | VW3A7742 | VW3A7752 | VW3A4554 | VW3A5304 | VW3A4711 | ATVRD15N4 |
| 15 | 20 | 18.5 | 25 | ATV340D15N4S | VW3A4432 | VW3M2606 | VW3A7733 | VW3A7743 | VW3A7753 | VW3A4554 | VW3A5304 | VW3A4711 | ATVRD15N4 |
| 18 | 25 | 22 | 30 | ATV340D18N4S | VW3A4432 | VW3M2606 | VW3A7733 | VW3A7743 | VW3A7753 | VW3A4555 | VW3A5304 | VW3A4712 | ATVRD15N4 |
| 22 | 30 | 30 | 40 | ATV340D22N4S | VW3A4432 | VW3M2606 | VW3A7733 | VW3A7743 | VW3A7753 | VW3A4555 | VW3A5305 | VW3A4712 | ATVRD15N4 |
| Pages | | | 22 | 25 | 25 | 49 | 50 | 50 | 53 | 55 | 51 | 57 | |

| Additional I/O modules | | |
|---|--------------------------|------|
| Description | Reference | Page |
| Extended I/O module | VW3A3203 | 38 |
| Extended relay module | VW3A3204 | 38 |
| Safety modules | | |
| Description | Reference | Page |
| Safety Module Advanced | VW3A3802 | 45 |
| PROFIsafe module | VW3A3807 | 46 |
| CIP Safety module | VW3A3809 | 47 |
| Encoder interface modules | | |
| Description | Reference | Page |
| Digital interface encoder module | VW3A3420 | 37 |
| Analog interface encoder module | VW3A3422 | 37 |
| Resolver interface module | VW3A3423 | 37 |
| HTL encoder interface module | VW3A3424 | 37 |
| List of fieldbus modules | | |
| Description | Reference | Page |
| CANopen daisy chain | VW3A3608 | 42 |
| CANopen SUB-D | VW3A3618 | 42 |
| CANopen open style communication module | VW3A3628 | 43 |
| PROFINET V2 | VW3A3647 | 44 |
| Profibus DP V1 | VW3A3607 | 44 |
| DeviceNet | VW3A3609 | 44 |
| POWERLINK communication module | VW3A3619 | 44 |
| EtherCAT 2 x RJ45 communication module | VW3A3601 | 44 |
| Additional module support | VW3A3800 | 47 |

| Module compatibility table | | | |
|---|---|---|--|
| Module type (1) | Modular, Ethernet, and Sercos drives GP-SF slot SlotC (2) | Modular, Ethernet, and Sercos drives GP-ENC SlotB (2) | Modular drive GP-FB slot SlotA (2) |
| Extended I/O VW3A3203 | Combination possible | Combination possible | Combination possible |
| Extended relay VW3A3204 | Combination possible | Combination possible | Combination possible |
| Fieldbuses VW3A3608, VW3A3618, VW3A3628, VW3A3607, VW3A3609, VW3A3601, VW3A3619, and VW3A3647 | Combination impossible | Combination impossible | Combination possible |
| Encoder interface modules VW3A3420, VW3A3422, VW3A3423, and VW3A3424 | Combination impossible | Combination possible | Combination possible |
| Safety VW3A3802, VW3A3809 (3), and VW3A3807 (4) | Combination possible | Combination impossible | Combination impossible |

 Combination possible
 Combination impossible



Slot GP-SF for drives up to 22 kW
 SlotC for drives above 22 kW equipped with VW3A3800

Slot GP-ENC for drives up to 22 kW
 SlotB for drives above 22 kW

Slot GP-FB for drives up to 22 kW
 SlotA for drives above 22 kW

(1) Two modules of the same type cannot be inserted in the Altivar Machine ATV340 variable speed drives simultaneously.
 (2) SlotA, SlotB, and SlotC are the markings on the ATV340D30...D75N4E drives. SlotC is available when additional module support VW3A3800 is installed.
 (3) CIP Safety module is only compatible with ATV340 Ethernet version ATV340...N4E.
 (4) The PROFIsafe module is compatible with modular ATV340...N4 and ATV340D30...D75N4E drives. To ensure PROFIsafe functionality, it is essential to plug the VW3A3647 PROFINET V2 card into the communication slot GP-FB or the Slot A.



Embedded encoder interface

Presentation

Altivar Machine ATV340 variable speed drives from ATV340U07...D22N4● have an on-board encoder interface. The on-board encoder interface 1 supports RS422 for A/B/I incremental and 1 Vpp for Sin/Cos signals.

References from ATV340D30...D75N4E● do not have an on-board encoder interface, however optional encoder modules can be used for flux vector control operation with sensor (FVC mode) for asynchronous motors, or for vector control operation with speed feedback (FSY mode) for synchronous motors.

They improve drive performance irrespective of the motor load state:

- Zero speed torque
- Accurate speed regulation
- Torque accuracy
- Shorter response times on a torque surge
- Improved dynamic performance in transient state

For asynchronous motors, encoder interface modules improve static speed accuracy in different control modes (voltage vector control, voltage/frequency ratio).

Depending on the model, encoder interface modules can also be used for monitoring, irrespective of the control type:

- Overspeed detection
- Load slipping detection

They can also transmit a reference value provided by the encoder input to the Altivar variable speed drive. This specific feature is used to synchronize the speed of several drives. The encoder options have a thermal sensor input to monitor one standard temperature sensor.

Three modules are available depending on the encoder technology:

- Resolver encoder
- Encoder with digital output
- Encoder with analog output

The Altivar variable speed drive can only be equipped with one of the encoder interface modules. The interface encoder module is inserted in a dedicated slot (see page 38).

It is protected against encoder supply short-circuits and overloads.



VW3A3422 analog interface encoder module



VW3A3424 HTL encoder interface module



VW3A3423 resolver interface encoder module



VW3A3420 digital interface encoder module 5/12 V

References

| Description | Technology type | Power supply | Maximum current | Maximum cable length | Maximum operating frequency | Supported thermal sensors | Reference | Weight |
|--|-------------------|---------------|-----------------|----------------------|-----------------------------|---|--------------------------|-----------------|
| | | V \pm | mA | m/ft | kHz | | | kg/lb |
| Resolver interface encoder module | Resolver | – | 50 | 100/328 | 3...12 | PTC (digital/linear), PT100, PT1000, Klixon | VW3A3423 | 0.150/ 0.331 |
| Digital interface encoder module 5/12 V | A/B/I | 5, 12, or 24 | 250, 100 | 100/328 | 1,000 | PTC (digital/linear), PT100, PT1000, Klixon | VW3A3420 | 0.150/ 0.331 |
| | SSI | 5, 12, or 24 | 250, 100 | 50/164 (1) | 1,000 (1) | | | |
| | EnDat® 2.2 | 5, 12, or 24 | 250, 100 | 50/164 (1) | 1,000 (1) | | | |
| Analog interface encoder module | 1 Vpp | 5, 12, or 24 | 250, 100 | 100/328 | 100 | PTC (digital/linear), PT100, PT1000, Klixon | VW3A3422 | 0.150/ 0.331 |
| | SinCos Hiperface® | 5, 12, or 24 | 250, 100 | 100/328 | 100 | | | |
| HTL encoder interface module | HTL | 12, 15, or 24 | 200, 175, 100 | 500/1,640 | 300 | – | VW3A3424 | 0.150/ 0.331 |

Connection accessories (2)

| Description | Composition | Length m/ft | Reference | Weight kg/lb |
|---|---|-------------|-------------------------------|-------------------|
| Cordset | | | | |
| Cordset equipped with 1 x 15-way high density male SUB-D connector for digital or analog encoder modules | – | 1/3.28 | VW3M4701 | – |
| Connecting cable | | | | |
| Cable for creating cordsets for encoder interface modules | 3 x (2 x 0.14 mm ² /AWG 26) + 2 x (2 x 0.34 mm ² /AWG 22) | 25/82.02 | VW3M8222R250 | 1.400/ 3.086 |
| | | 50/164.04 | VW3M8222R500 | 2.800/ 6.173 |
| | | 100/328.08 | VW3M8222R1000 | 5.600/ 12.346 |
| | 5 x (2 x 0.25 mm ² /AWG 24) + 1 x (2 x 0.5 mm ² /AWG 20) | 100/328 | VW3M8221R1000 | 21.000/ 46.297 |

(1) With propagation delay compensation on EnDat® up to 100 m/328 ft and higher maximum frequencies possible, SSI 300 kHz up to 100 m/328 ft possible.

(2) See the complete list of connection accessories on [our website](#).

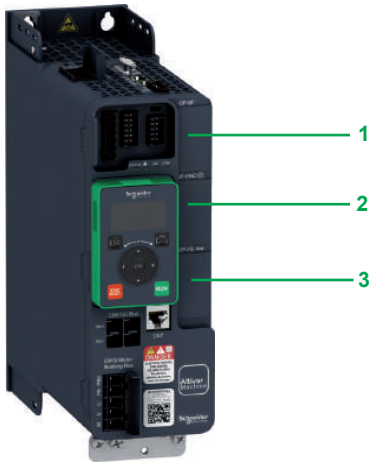

ATV340 Ethernet drives equipped with plain text display terminal



VW3A3203



VW3A3204

Additional I/O modules

Presentation

By installing additional I/O modules Altivar Machine drives can be adapted to meet the needs of applications that manage additional sensors or specific sensors.

Two additional modules are available:

- The extended I/O module, with digital and analog I/O
- The extended relay module, with relay outputs

These modules are inserted in slots 1 and 2 on Altivar Machine drives:

- 1 GP-SF slot for additional I/O or Safety function modules
- 2 GP-ENC slot for additional I/O or encoder modules
- 3 GP-FB slot for additional I/O or communication option modules

Extended I/O module

- 2 differential analog inputs configurable via software as current (0-20 mA/4-20 mA), or for PTC, PT100, or PT1000 probes, 2- or 3-wire
- 14-bit resolution
- 6 x 24 V \pm positive or negative digital inputs
- Sampling: 1 ms max
- 2 assignable digital outputs
- 2 removable spring terminal blocks

Extended relay module

- 3 relay outputs with NO contacts
- 1 fixed screw terminal block

Additional I/O modules

| Description | I/O type | | | | Reference | Weight kg/lb |
|-----------------------|----------------|-----------------|---------------|---------------|-----------|-----------------|
| | Digital inputs | Digital outputs | Analog inputs | Relay outputs | | |
| Extended I/O module | 6 | 2 | 2 (1) | – | VW3A3203 | – |
| Extended relay module | – | – | – | 3 (2) | VW3A3204 | – |

(1) Differential analog inputs configurable via software as current (0-20 mA/4-20 mA), voltage (+/- 10V), or for PTC, PT100, or PT1000 probes, 2- or 3-wire. When configured as PTC probe inputs, they must never be used to protect an ATEX motor in applications in explosive atmospheres. Please refer to the ATEX guide on [our website](#).

(2) NO contacts.

Note: The extended I/O and relay modules can be placed in slot A or slot B for reference ATV340D30...D75N4E on Altivar Machine ATV340 variable speed drives. For more details, please refer to the instruction sheets, [EAV76404](#) and [EAV76405](#).

Two modules of the same type cannot be inserted in Altivar Machine ATV340 variable speed drives.



ATV340 Ethernet drive equipped with plain text display terminal



ATV340 Sercos drive equipped with plain text display terminal

Presentation

Altivar Machine ATV340 drives are designed to meet configuration requirements found in the main industrial communication installations.

ATV340 variable speed drives have a Modbus serial line port **2** as standard, a single port for connecting the display, and a single port for connection to the configuration tool. ATV340●●●N4E● Ethernet-type drives are equipped with multi-Ethernet protocol. EtherNet/IP and Modbus TCP are available as standard with dual RJ45 ports **4**. ATV340●●●N4S drives are equipped with a Sercos protocol as standard with dual RJ45 ports **5**.

Modbus serial link

There are two ports using Modbus RTU protocol for connecting to the HMI and commissioning.

The HMI serial link port is designed for simple integration of the Harmony HMI terminal:

- Harmony HMI terminal
- Remote plain text display terminal **1**, remote graphic display terminal

The commissioning port **2** is used to configure the parameters or monitor the status of the variable speed drive, using SoMove setup software

Dual port multi-Ethernet communication

Altivar Machine ATV340 Ethernet drives integrate the EtherNet/IP and Modbus TCP communication protocols as standard.

- EtherNet/IP and Modbus TCP dual port **4**

This offers the standard services regularly used in industrial networks: connection to the Modbus TCP or EtherNet/IP network

- EtherNet/IP adapter including standard CIP objects (AC/DC drive objects, CIP energy objects, etc.), compliant with ODVA specification

- The RSTP connection allows ring topology to help ensure continuity of service.

- The dual port allows daisy-chain connection to simplify cabling and network infrastructure (no need to use a switch).

- Modbus TCP message handling is based on the Modbus protocol and is used to exchange process data with other network devices (e.g., a PLC). It provides ATV340E drives with access to the Modbus protocol and to the high performance of the Ethernet network, which is the communication standard for numerous devices.

- SNMP (Simple Network Management Protocol) offers standard diagnostics services for network management tools.

- The FDR (Fast Device Replacement) service allows automatic reconfiguration of a new device installed to replace an existing device.

- Device security is reinforced by disabling some unused services as well as managing a list of authorized devices.

- Setup and adjustment tools (SoMove, EcoStruxure Machine Expert with DTM) can be connected locally or remotely.

- The embedded Web server is used to display operating data and dashboards as well as to configure and diagnose system elements from any Web browser.

These numerous services offered by Altivar Machine ATV340E drives simplify integration into Schneider Electric machine automation controllers such as M241 and M251.

Altivar Machine ATV340 Sercos drives integrate the Sercos communication protocols as standard.

- Sercos dual port **5**

This offers the standard services regularly used in industrial networks: connection to Sercos network

- Sercos allows ring topology to help ensure continuity of service.

- The dual port allows daisy chain connection to simplify cabling and network infrastructure (no need to use a switch).

- The FDR (Fast Device Replacement) service allows a user reconfiguration of a new device installed to replace an existing device.

- Setup and adjustment tools (SoMove with DTM over Serial Line) can be connected.

Communication modules for industrial applications

The following communication modules are available as options (1):

- CANopen
- PROFIBUS DP V1
- DeviceNet
- EtherCAT
- PROFINET
- POWERLINK

(1) Not compatible with Sercos drive.

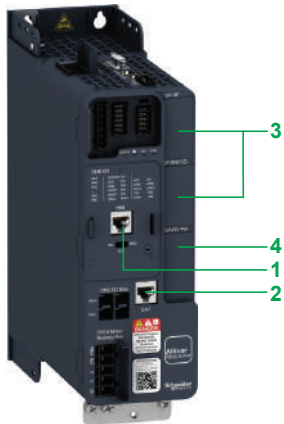

ATV340 modular drive

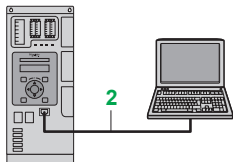

ATV340 Modular drive using Modbus to connect drive with the basic display terminal and PC

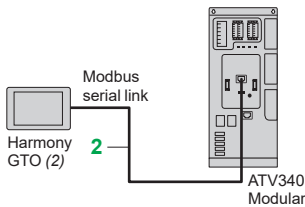

Example of connecting a modular ATV340 drive to a Harmony GTO HMI terminal via the Modbus serial link

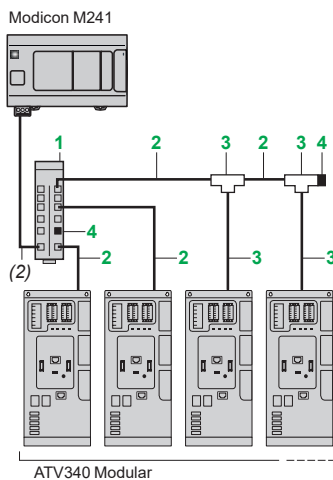

Example of Modbus diagram with connection via splitter box and RJ45 connectors

Description

Altivar Machine ATV340 drives have been designed to simplify connections to communication buses by means of the following:

- 1 Integrated RJ45 communication port for HMI on the front
- 2 Integrated RJ45 communication port for Modbus on the front
- 3 Slots available for the additional I/O modules (see [page 38](#)), encoder modules (see [page 37](#)), and Safety function module (see [page 35](#))
- 4 Slots available for inserting communication modules in ATV340 modular drives, ATV340...N4

Functions

Altivar Machine ATV340 drive functions can be accessed via the communication buses:

- Control
- Monitoring
- Adjustment
- Configuration

The speed reference and command may come from different sources:

- Digital input or analog I/O terminals
- Communication bus
- Remote/Local display terminals
- PTI interface (1)

As one of the advanced functions, ATV340 drive control sources can be managed and switched according to the application requirements.

The communication periodic I/O data assignment can be selected using the network configuration software.

The ATV340 Modular and Ethernet drives can be controlled:

- According to the CiA 402 native profile
- According to the I/O profile

The ATV340 Sercos drives are controlled by Sercos.

Communication is monitored according to criteria specific to each protocol.

Regardless of protocol type, the response of the drive to a detected communication interruption can be configured as follows:

- Freewheel stop, stop on ramp, fast stop, or braked stop
- Maintain the last command received
- Fallback position at a predefined speed
- Ignore the detected error

Modbus serial link

Connection accessories for remote Human Machine Interface (2)

| Description | Item no. | Length m/ft | Reference | Weight kg/lb |
|---|----------|-------------|------------------------------|-----------------|
| Modbus splitter box 10 RJ45 connectors and 1 screw terminal block | 1 | - | LU9GC3 | 0.500/ 0.110 |
| Cordsets for Modbus serial link equipped with 2 RJ45 connectors | 2 | 0.3/0.98 | VW3A8306R03 | 0.025/ 0.055 |
| | | 1/3.28 | VW3A8306R10 | 0.060/ 0.132 |
| | | 3/9.84 | VW3A8306R30 | 0.130/ 0.287 |
| Modbus T-junction boxes (with integrated cable) | 3 | 0.3/0.98 | VW3A8306TF03 | 0.190/ |
| | | 1/3.28 | VW3A8306TF10 | 0.210/ |
| Line terminators for RJ45 connector Set of 2 | 4 | - | VW3A8306RC | 0.020/ 0.044 |
| | | - | VW3A8306R | 0.020/ 0.044 |

(1) PTI interface is available for ATV340U07...DD22N4 and ATV340U07...D22N4E drives.

(2) See [page 27](#) for connection of a remote display terminal or remote graphic display terminal. Requires a 24 V \square power supply. Please consult the [HMI page](#) on our website.

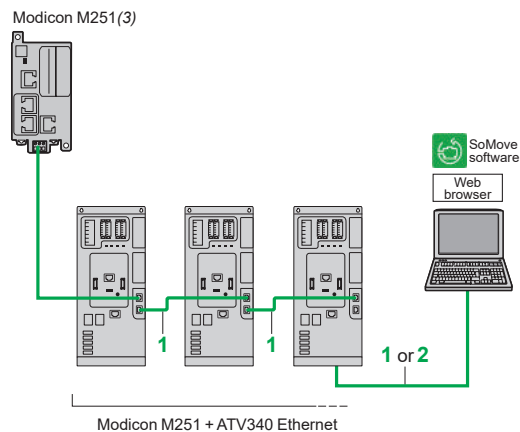

Example of connection on an EtherNet/IP network

Modbus TCP network and EtherNet/IP network

| Description | Item no. | Length m/ft (2) | Reference | Weight kg/lb |
|--|----------|-----------------|---------------------|-----------------|
| ConneXium cordsets (1) (2) | | | | |
| Straight shielded twisted pair cordsets | 1 | 2/ 6.56 | 490NTW00002 | — |
| equipped with 2 RJ45 connectors | | 5/ 16.4 | 490NTW00005 | — |
| Conforming to EIA/TIA-568 category 5 and IEC 11801/EN 50173-1, class D standards | | 12/ 39 | 490NTW00012 | — |
| Crossed shielded twisted pair cordsets | 2 | 5/ 16.4 | 490NTC00005 | — |
| equipped with 2 RJ45 connectors | | 15/ 49 | 490NTC00015 | — |
| Conforming to EIA/TIA-568 category 5 and IEC 11801/EN 50173-1, class D standards | | | | |
| Straight shielded twisted pair cordsets | 1 | 2/ 6.56 | 490NTW00002U | — |
| equipped with 2 RJ45 connectors | | 5/ 16.4 | 490NTW00005U | — |
| Conforming to UL and CSA 22.1 standards | | 12/ 39 | 490NTW00012U | — |
| Sercos cables | | | | |
| Sercos cables for redundant Sercos ring | | 0.5/ 1.64 | VW3E5001R005 | 0.045/ 0.100 |
| equipped with 2 RJ45 connectors | | 1/ 3.28 | VW3E5001R010 | 0.045/ 0.100 |
| | | 1.5/ 4.92 | VW3E5001R015 | 0.045/ 0.100 |
| | | 2/ 6.56 | VW3E5001R020 | 0.045/ 0.100 |
| | | 3/ 9.84 | VW3E5001R030 | 0.045/ 0.100 |
| | | 5/ 16.4 | VW3E5001R050 | 0.045/ 0.100 |
| | | 10/ 33 | VW3E5001R100 | 0.045/ 0.100 |
| | | 15/ 49 | VW3E5001R150 | 0.045/ 0.100 |
| | | 20/ 66 | VW3E5001R200 | 0.045/ 0.100 |
| | | 25/ 82 | VW3E5001R250 | 0.045/ 0.100 |
| | | 30/ 98 | VW3E5001R300 | 0.045/ 0.100 |
| | | 40/ 131 | VW3E5001R400 | 0.045/ 0.100 |
| | | 50/ 164 | VW3E5001R500 | 0.045/ 0.100 |

(1) For other ConneXium connection accessories, please refer to the [Modicon Networking](#) and the [NEMA Contactors and Starters: Digest Section 16](#) catalogs.

(2) Also available in 40 m/131 ft and 80 m/262 ft lengths (1).

(3) Please refer to the [Modicon M251 Logic controllers](#) catalog.

Variable speed drives

Altivar Machine ATV340

Communication buses



VW3A3608

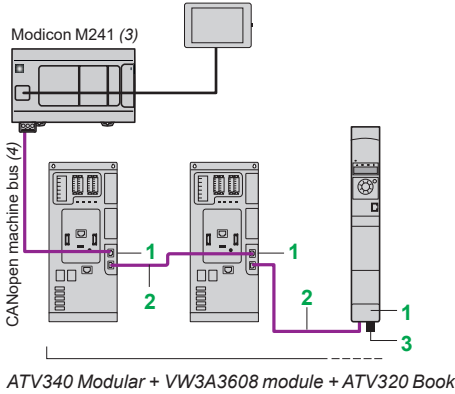

VW3A3618

CANopen machine bus

| Description | Item no. | Length m/ft | Unit reference | Weight kg/lb |
|-------------|----------|-------------|----------------|--------------|
|-------------|----------|-------------|----------------|--------------|

Connection with VW3A3608 CANopen daisy chain module (optimized solution for daisy-chain connection to the CANopen machine bus)

| | | | | |
|---|----------|---|-----------------|---|
| CANopen daisy chain communication module Ports: 2 RJ45 connectors | 1 | – | VW3A3608 | – |
|---|----------|---|-----------------|---|

| | | | | |
|--|----------|--------------|---------------------|-----------------|
| CANopen cordsets equipped with 2 RJ45 connectors | 2 | 0.3/ 0.98 | VW3CANCARR03 | 0.050/ 0.110 |
| | | 1/ 3.28 | VW3CANCARR1 | 0.500/ 1.102 |

| | | | | |
|--|----------|---|----------------------|---|
| CANopen line terminator for RJ45 connector | 3 | – | TCSCAR013M120 | – |
|--|----------|---|----------------------|---|

| | | | | |
|---|--|--------------|-------------------------|---|
| CANopen terminal adapter 2 RJ45 connectors for daisy-chain connection | | 0.3/ 0.98 | TCSCCTN023F13M03 | – |
|---|--|--------------|-------------------------|---|

Connection via SUB-D connector with VWA3618 CANopen module

| | | | | |
|---|--|---|-----------------|---|
| CANopen communication module Port: 1 x 9-way male SUB-D connector | | – | VW3A3618 | – |
|---|--|---|-----------------|---|

| | | | | |
|---|--|-------------|--------------------|-------------------|
| CANopen cable Standard cable, CE marking Low smoke zero halogen Flame retardant (IEC 60332-1) | | 50/ 164 | TSXCANCA50 | 4.930/ 10.869 |
| | | 100/ 328 | TSXCANCA100 | 8.800/ 19.401 |
| | | 300/ 984 | TSXCANCA300 | 24.560/ 54.145 |

| | | | | |
|--|--|-------------|--------------------|-------------------|
| CANopen cable Standard cable, UL certification, CE marking Flame retardant (IEC 60332-2) | | 50/ 164 | TSXCANCB50 | 3.580/ 7.892 |
| | | 100/ 328 | TSXCANCB100 | 7.840/ 17.284 |
| | | 300/ 984 | TSXCANCB300 | 21.870/ 48.215 |

| | | | | |
|--|--|-------------|--------------------|-------------------|
| CANopen cable Cable for harsh environments (1) or mobile installations, CE marking Low smoke zero halogen Flame retardant (IEC 60332-1) | | 50/ 164 | TSXCANCD50 | 3.510/ 7.738 |
| | | 100/ 328 | TSXCANCD100 | 7.770/ 17.130 |
| | | 300/ 984 | TSXCANCD300 | 21.700/ 47.840 |

| | | | | |
|--|--|---|-----------------|-----------------|
| CANopen bus connector with line terminator - one 9-way female SUB-D connector | | – | VW3M3802 | 0.175/ 0.386 |
|--|--|---|-----------------|-----------------|

| | | | | |
|---|--|---|-----------------------|---|
| CANopen connector SUB-D9 with line terminator (can be disabled). 180° cable outlet for 2 CANopen cables CAN-H, CAN-L, CAN-GND connection | | – | VW3CANKCDF180T | – |
|---|--|---|-----------------------|---|

| | | | | |
|--|--|---|-----------------------|-----------------|
| CANopen IP20 straight connector SUB-D9 with line terminator (can be disabled) | | – | TSXCANKCDF180T | 0.049/ 0.108 |
|--|--|---|-----------------------|-----------------|

| | | | | |
|---|--|---|----------------------|-----------------|
| IP20 CANopen right angle connector (2) SUB-D9 with line terminator (can be disabled) | | – | TSXCANKCDF90T | 0.046/ 0.101 |
|---|--|---|----------------------|-----------------|

- (1) *Standard environment:*
- No particular environmental constraints
 - Operating temperature between 5 and 60 °C/41 and 140 °F
 - Fixed installation
- Harsh environment:*
- Resistance to hydrocarbons, industrial oils, detergents, solder splashes
 - Relative humidity up to 100%
 - Saline atmosphere
 - Operating temperature between -10 and +70 °C/14 and 158 °F
 - Significant temperature variations
- (2) *Incompatible with side-by-side mounting.*
- (3) Please refer to the [Modicon M241 logic controller catalog](#), [Modicon M251 logic controller catalog](#), and [Harmony SCU HMI controllers catalog](#).
- (4) Cable dependent on the type of controller or PLC; please refer to the corresponding catalog on [our website](#).

Variable speed drives

Altivar Machine ATV340

Communication buses

LXM52_CP21043



VW3A3628

| CANopen machine bus (continued) | | | |
|---|----------------|----------------------|-----------------|
| Description | Length m/ft | Unit reference | Weight kg/lb |
| Connection via terminals with VW3A3628 CANopen module | | | |
| CANopen open style communication module Port: 1 x 5-way spring terminal block | – | VW3A3628 | – |
| CANopen line terminator for spring terminal connector | – | TCSCAR01NM120 | – |
| Other connection accessories and cordsets | | | |
| IP20 CANopen cordsets equipped with 2 x 9-way female SUB-D connectors. | 0.3/ 0.98 | TSXCANCADD03 | 0.091/ 0.201 |
| Standard cable, CÉ marking | 1/ | TSXCANCADD1 | 0.143/ 0.315 |
| Low smoke zero halogen | 3.28 | TSXCANCADD3 | 0.295/ 0.650 |
| Flame retardant (IEC 60332-1) | 3/ 9.84 | TSXCANCADD3 | 0.295/ 0.650 |
| | 5/ 16.4 | TSXCANCADD5 | 0.440/ 0.970 |
| IP20 CANopen cordsets equipped with 2 x 9-way female SUB-D connectors. | 0.3/ 0.98 | TSXCANCBDD03 | 0.086/ 0.190 |
| Standard cable, UL certification, CÉ marking | 1/ | TSXCANCBDD1 | 0.131/ 0.289 |
| Flame retardant (IEC 60332-2) | 3/ 9.84 | TSXCANCBDD3 | 0.268/ 0.591 |
| | 5/ 16.4 | TSXCANCBDD5 | 0.400/ 0.882 |
| CANopen terminal adapter 2 spring terminals for daisy-chain connection | 0.6/ 1.96 | TCSCTN026M16M | – |
| IP20 CANopen junction boxes equipped with: ■ 4 x 9-way male SUB-D connectors + screw terminal block for trunk cable tap link ■ Line terminator | – | TSXCANTDM4 | 0.196/ 0.432 |
| IP20 CANopen junction boxes equipped with: ■ 2 screw terminal blocks for trunk cable tap link ■ 2 RJ45 connectors for connecting drives ■ 1 RJ45 connector for connecting a PC | – | VW3CANTAP2 | 0.480/ 1.058 |

Variable speed drives

Altivar Machine ATV340

Communication buses



VW3A3607

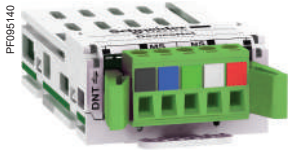

VW3A3609



VW3A3601



VW3A3647



VW3A3619

PROFIBUS DP V1 bus

| Description | Reference | Weight kg/lb |
|--|--------------------------|-----------------|
| PROFIBUS DP V1 communication module Port: 1 x 9-way female SUB-D connector Conforming to PROFIBUS DP V1 Profiles supported: ■ CiA 402 drive ■ Profidrive Offers several message handling modes based on DP V1 | VW3A3607 | 0.140/ 0.308 |



DeviceNet bus

| Description | Reference | Weight kg/lb |
|--|--------------------------|-----------------|
| DeviceNet communication module Port: 1 removable 5-way screw connector Profiles supported: ■ CIP AC DRIVE ■ CiA 402 drive | VW3A3609 | 0.300/ 0.661 |

EtherCAT bus

| Description | Reference | Weight kg/lb |
|---|--------------------------|-----------------|
| EtherCAT communication module Port: 2 RJ45 connectors | VW3A3601 | 0.290/ 0.639 |

PROFINET network

| Description | Reference | Weight kg/lb |
|---|--------------------------|-----------------|
| Communication module PROFINET V2 Port: 2 RJ45 connectors <ul style="list-style-type: none"> ■ Compliant with Architecture S1 and S2 Redundancy on PROFINET ■ Automatic IP address assignment via DHCP and DCP ■ Automatic configuration data via iPar-Server ■ Support of MRP (Media Redundancy Protocol) ■ PNIO_Version V2.44 ■ PROFIDRIVE Version 4.2 ■ Support of LLDP (Link Layer Discovery Protocol) ■ Security Level 1 Class III ■ Conformance Class B   | VW3A3647 | 0.300/ 0.660 |

POWERLINK network

| Description | Reference | Weight kg/lb |
|---|--------------------------|-----------------|
| Ethernet POWERLINK communication module Port: 2 RJ45 connectors | VW3A3619 | 0.300/ 0.660 |

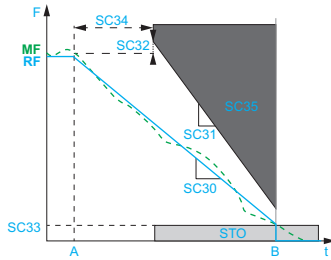

Activation of the SS1 function

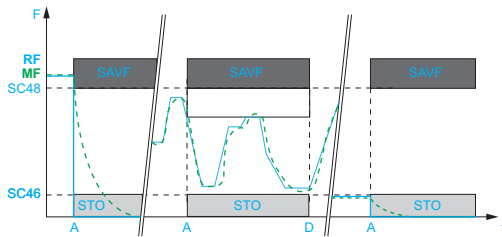

Activation of the SLS function

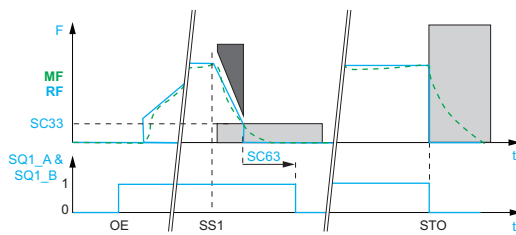

Activation of the SBC function

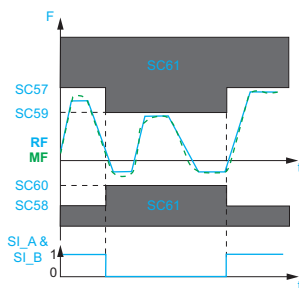

Activation of the SMS function



VW3A3802 Safety module



VW3M8820

Presentation

The Safety Module Advanced allows ATV340 variable speed drives to access additional Safety functions.

This creates a complex functional Safety device that helps to provide installation monitoring.

The Safety Module Advanced optimizes the overall cost of the installation by avoiding the need for additional external devices, while conforming to international safety standards. As a result, wiring is cheaper and quicker.

It also improves performance during maintenance by reducing machine or installation downtime and helps to ensure work is carried out in compliance with safety standards.

It includes the following Safety functions compliant with standard IEC/EN 61800-5-2.

- Safe Stop 1 (SS1)
- Safe Limited Speed (SLS)
- Safe Brake Control (SBC)

In addition, the Safety Module Advanced includes two additional Safety functions.

- Safe Maximum Speed (SMS)
- Guard Door Locking (GDL)

Safety functions

Safe Stop 1 (SS1) function

The SS1 integrated Safety function causes a category 1 safe stop.

This function monitors deceleration according to a dedicated deceleration ramp and safely shuts off the torque once standstill has been achieved.

Safe Limited Speed (SLS) function

The SLS integrated Safety function can be initiated by activating Safety function inputs. This function helps to prevent the motor from exceeding the specified speed limit. If the motor speed exceeds the specified speed limit value, safety function STO is triggered.

Safe Brake Control (SBC) function

The SBC integrated Safety function provides a safe output signal to command an external relay in order to control external brakes.

Safe Maximum Speed (SMS) function

This function helps to prevent the speed of the motor from exceeding the predefined speed limit.

- Two different speed limits can be defined and can be selected by logic inputs.
- If the motor speed exceeds the predefined speed limit value, Safety function STO is triggered.

Once the SMS function is configured, it is continuously active.

Guard Door Locking (GDL) function

The GDL function allows the guard door lock to be released when the motor power is turned off.

References

| Description | Power supply | Cable length m/ft | Unit reference | Weight kg/lb |
|--|-----------------------------|----------------------|--------------------|-----------------|
| | V | | | |
| Safety Module Advanced | 24 V $\overline{\text{DC}}$ | – | VW3A3802 | – |
| Cordset Preassembled with 2 x 24-way female connectors (Safety module end) and a free end | – | 3/ 9.84 | VW3M8801R30 | 0.020/ 0.040 |
| Cordsets Preassembled with 2 x 24-way female connectors | – | 1.5/ 4.92 | VW3M8802R15 | 0.020/ 0.040 |
| | | 3/ 9.84 | VW3M8802R30 | 0.150/ 0.330 |
| Safety module distribution unit Connection terminal adapter for Safety module, for easy wiring of several Safety modules in the control cabinet (equipped with 5 connectors) | – | – | VW3M8810 | – |
| Removable connector To connect an additional Safety module distribution unit | – | – | VW3M8820 | – |

Sold in lots of 4

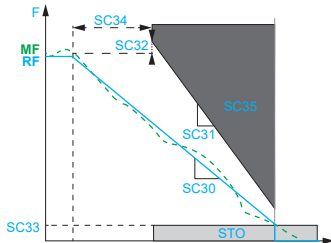

Activation of the SS1 function

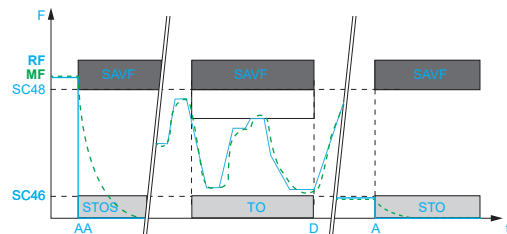

Activation of the SLS function

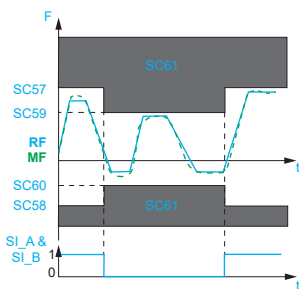

Activation of the SMS function

Presentation

The PROFIsafe module allows ATV340 variable speed drives to provide a fail-safe Ethernet connection between the drive and a safety PLC using the PROFIsafe protocol over PROFINET V2.

ATV340 is connected over Ethernet via the communication module PROFINET V2 (VW3A3647), allowing communication with the PROFIsafe module through tunneling functionality

It includes the following safety functions compliant with the IEC/EN 61800-5-2 standard:

- Safe Torque Off (STO)
- Safe Stop 1 (SS1)
- Safe Limited Speed (SLS)

The safety module also includes one additional safety functions:

Safe Maximum Speed (SMS)

Safety functions

Safe Torque Off (STO) function

The PROFIsafe module activates the integrated STO safety function of the drive, ensuring that no power capable of causing torque or force is supplied to the motor.

Safe Stop 1 (SS1) function

The SS1 integrated safety function causes a category 1 safe stop. This function monitors the deceleration according to a dedicated deceleration ramp and shuts off the torque once standstill has been achieved.

Safely Limited Speed (SLS) function

The SLS integrated safety function can be initiated by activating safety function inputs. This function helps to prevent the motor from exceeding the specified speed limit. If the motor speed exceeds the specified speed limit value, safety function STO is triggered.

Safe Maximum Speed (SMS) function

This function helps to prevent the speed of the motor from exceeding the predefined speed limit.

Once the SMS function is configured, it is continuously active.

Conformity test

PROFIsafe V2.6 release.

References

| Description | Unit reference | Weight |
|----------------------|----------------|------------------|
| | | kg/lb |
| PROFIsafe module (3) | VW3A3807(1)(2) | 0.150 / 0.330 |

(1) Please refer to ATV340 PROFIsafe Manual to verify firmware compatibility.

(2) The PROFIsafe module is compatible with modular ATV340...N4 and ATV340D30...D75N4E drives. To ensure PROFIsafe functionality, it is essential to plug the VW3A3647 PROFINET V2 card into the communication slot GP-FB or the Slot A.

(3) To ensure PROFIsafe functionality, it is essential to plug the PROFIsafe module VW3A3807 into the communication slot GP-SF or the Slot C

PF151306



VW3A3807 PROFIsafe module

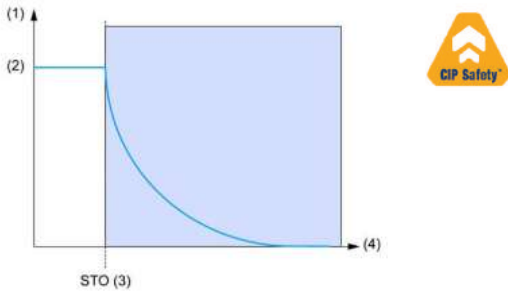

- (1) Motor Speed
- (2) Actual Speed
- (3) STO function triggered from CIP Safety Over EtherNet/IP by command safe word
- (4) Time

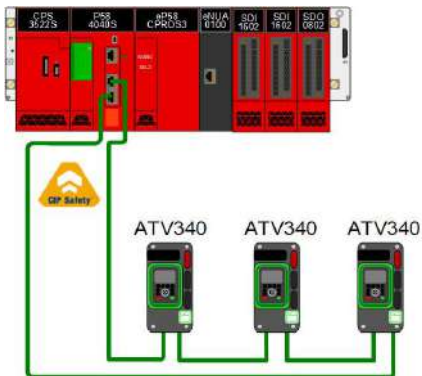

CIP Safety architecture

VW3A3809_Main



VW3A3809 CIP Safety module

Presentation

The CIP Safety module allows ATV340 variable speed drive to provide a fail-safe Ethernet connection between the drive and a Safety PLC using Safety over EtherNet/IP protocol.

ATV340 is connected on the Ethernet connection with its embedded EtherNet/IP that allows to go up to the CIP Safety Module thanks to the tunneling functionality.

It includes the following safety function, compliant with the IEC/EN 61800-5-2 standard:

- Safe Torque Off (STO) function SIL3/Ple (2) (3).

The CIP Safety module is compatible with ATV340 firmware V2.1IE82 and higher.

Safety functions

Safe Torque Off (STO) function

This safety function activates the STO function in the drive.

No power that could cause torque or force is supplied to the motor.

Safety Profile

| | |
|--------------|---|
| Safety I/O | Number of connections: 3 |
| EtherNet/IP: | 1 Connection for CIP I/O |
| CIP Safety: | 2 Connections, one for Safety Input and one for Safety Output |

Safety Open Type Type 2a; Type 2b

Conformity test ODVA CT18-ES

References

| Description | Unit reference | Weight kg/lb |
|-----------------------|------------------|-----------------|
| CIP Safety module (3) | VW3A3809 (1) (2) | 0.150/ 0.330 |

(1) Please refer to [ATV340 CIP Safety Manual](#) to verify firmware compatibility.

(2) The Altivar ATV340 above 22 kW (ATV340D30...ATV340D75N4E●) must be equipped with an additional module support VW3A3800 to be able to insert the CIP Safety module VW3A3809.

(3) CIP Safety module is only compatible with ATV340 Ethernet version ATV340...N4E●.

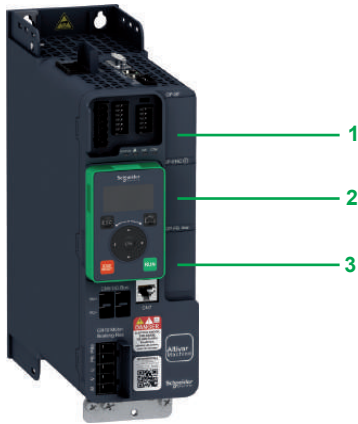

Safety module in the GP-SF slot



Safety module in the GP-SF slot and connector

Safety module

Presentation

The Safety module allows ATV340 variable speed drives to access additional Safety functions.

This creates a complex Safety device that helps to provide installation monitoring.

- 1 GP-SF slot for additional I/O or Safety function modules
- 2 GP-ENC slot for additional I/O or encoder modules
- 3 GP-FB slot for additional I/O or communication option modules

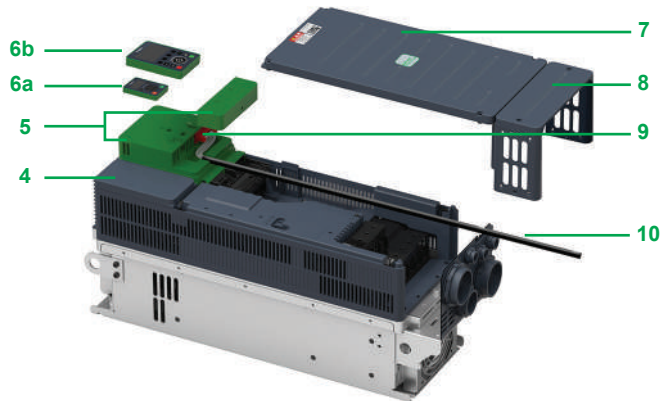

Another form of ATV340 with VW3A1111 (advanced keypad), and VW3A3800 (Hoist option), and connector under front cover and conduit box

- 4 ATV340D37N4E
- 5 Additional module support VW3A3800
- 6a Plain text display terminal VW3A1113
- 6b Graphic display terminal VW3A1111
- 7 Front cover
- 8 Conduit box
- 9 Safety modules
- 10 Cordset

Additional module support

Presentation

The additional module support allows ATV340 drives above 22 kW/30 HP to have an additional third slot for option modules such as additional I/O, fieldbus, encoder interface, and Safety module.

ATV340 drives above 22 kW must be equipped with an additional module support VW3A3800 in order to accommodate the Safety modules.



VW3A3800

References

| Description | Reference |
|--|----------------------------------|
| Safety modules | |
| Safety function module, extended Safety level | VW3A3802 |
| CIP Safety over EtherNet/IP module | VW3A3809 (1) |
| PROFIsafe over PROFINET module | VW3A3807 (2) (3) |
| Additional module support | |
| Additional module to be used in the range above 22 kW ATV340D30N4E ●...ATV340D75N4E ● | VW3A3800 |

(1) CIP Safety module is only compatible with ATV340 Ethernet version ATV340...N4E.

(2) PROFIsafe Module is only compatible with ATV340 Modular up to 22 kW, and ATV340D30...D75N4E● drives above 22kW.

(3) To ensure PROFIsafe functionality, it is essential to plug the VW3A3647 PROFINET V2 card into the communication slot GP-FB or the Slot A.

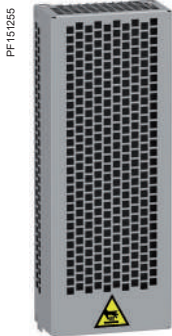

VW3A7741

Presentation

Braking resistors allow Altivar Machine ATV340 drives to operate while braking to a standstill, by dissipating the braking energy. They enable maximum transient braking torque.

Braking resistors are designed to be located outside the enclosure, but should not inhibit natural cooling. Air inlets and outlets must not be obstructed in any way. The air should be free of dust, corrosive gas, and condensation.

The internal circuits of Altivar Machine drives have a built-in dynamic braking transistor. Depending on the drive rating, the enclosed external braking resistor with IP20 and IP23 protection is designed to comply with the EMC standard and monitored by a temperature-controlled switch or thermal overload relay.

Thermal monitoring

Braking resistors from VW3A7733 to VW3A7738 and from VW3A7742 to VW3A7756 are equipped with a thermal switch to detect overheating of the resistor. This thermal switch must be used upstream to the drive to switch off the mains contactor in case of overheating detection.

For more details, please refer to the wiring diagrams provided in the [Instruction sheet - Braking resistors VW3A7730...757](#).

Applications

Braking resistors are designed for a defined cycle (see the 3 cycle types defined below). Depending on your own applications and cycles, you can use these resistors or define a new value.

- Braking resistors for light braking cycles for machines with cycles and inertia. The braking power is limited to 1.5 Tn for 0.8 s every 40 s.
- Braking resistors for medium braking cycles for machines with high inertia and conveyors. The braking power is limited to 1.35 Tn for 4 s every 40 s.
- Braking resistors for severe braking cycles for machines with very high inertia and vertical movements (hoisting). The braking power is limited to 1.65 Tn for 6 s and Tn for 54 s every 120 s.

Below are the list of the associated braking resistors according to the required braking cycle (1).

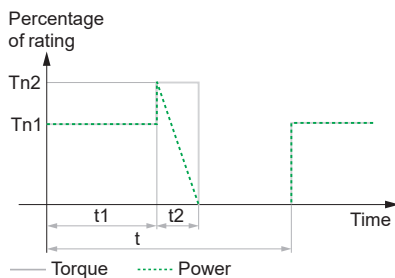

| Light cycle | |
|-----------------------|------------------------|
| $t = 40 \text{ s}$ | t : period |
| $t1 = 0 \text{ s}$ | $Tn1$: braking torque |
| $t2 = 0.8 \text{ s}$ | $Tn2$: braking torque |
| $Tn1 = 0$ | Tn : nominal torque |
| $Tn2 = 1.5 \times Tn$ | |

Light braking cycle

References for a light braking cycle

| For drives | Degree of protection of the resistor | Ohmic value at 20 °C/ 68 °F | Average power available at 50 °C/ 122 °F (2) | Quantity required per drive | Reference | Weight |
|---|--------------------------------------|-----------------------------|--|-----------------------------|--------------------------|-------------------|
| | | Ω | kW | | | kg/lb |
| Supply voltage: 380...480 V 50/60 Hz | | | | | | |
| ATV340U07...U30N4● | IP20 | 100 | 0.1 | 1 | VW3A7730 | 1.500/ 3.307 |
| ATV340U40...U55N4● | IP20 | 60 | 0.16 | 1 | VW3A7731 | 2.000/ 4.409 |
| ATV340U75...D11N4● | IP20 | 28 | 0.3 | 1 | VW3A7732 | 3.000/ 6.614 |
| ATV340D15...D22N4● | IP20 | 16 | 1.1 | 1 | VW3A7733 | 4.000/ 8.818 |
| ATV340D30...D37N4E● | IP20 | 10 | 1.1 | 1 | VW3A7734 | 5.500/ 12.125 |
| ATV340D45N4E● | IP20 | 8 | 1.1 | 1 | VW3A7735 | 5.500/ 12.125 |
| ATV340D55...D75N4E● | IP23 | 5 | 1.9 | 1 | VW3A7736 | 18.000/ 39.683 |

(1) The minimum braking resistor ohmic value of the drive can be found in the installation manual. For more information, please visit [our website](#).

(2) Load factor for resistors: The value of the average power that can be dissipated at 50 °C/122 °F from the resistor into the casing is determined for a load factor during braking that corresponds to the majority of normal applications:
 - Normal duty: 0.8 s braking with a 1.2 Tn braking torque for a 40 s cycle
 - Heavy duty: 0.8 s braking with a 1.5 Tn braking torque for a 40 s cycle

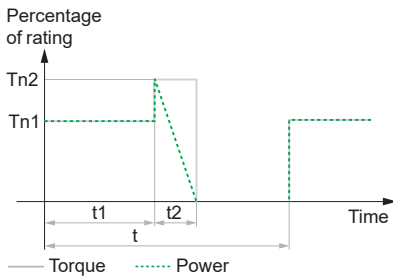

| Medium cycle | |
|------------------------|------------------------|
| $t = 40\text{ s}$ | t : period |
| $t1 = 0\text{ s}$ | $Tn1$: braking torque |
| $t2 = 4\text{ s}$ | $Tn2$: braking torque |
| $Tn1 = 0$ | Tn : nominal torque |
| $Tn2 = 1.35 \times Tn$ | |

Medium braking cycle

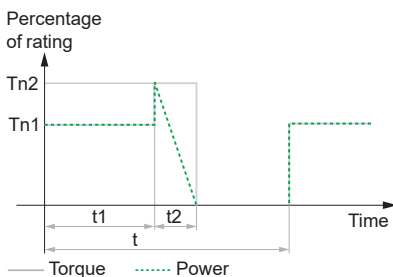

| Severe cycle | |
|------------------------|------------------------|
| $t = 120\text{ s}$ | t : period |
| $t1 = 54\text{ s}$ | $Tn1$: braking torque |
| $t2 = 6\text{ s}$ | $Tn2$: braking torque |
| $Tn1 = Tn$ | Tn : nominal torque |
| $Tn2 = 1.65 \times Tn$ | |

Severe braking cycle

References for a medium braking cycle

| For drives | Degree of protection of the resistor | Ohmic value at 20 °C/ 68 °F | Average power available at 50 °C/ 122 °F (1) | Quantity required per drive | Reference | Weight |
|---|--------------------------------------|-----------------------------|--|-----------------------------|-----------|----------------|
| | | Ω | kW | | | kg/lb |
| Supply voltage: 380...480 V 50/60 Hz | | | | | | |
| ATV340U07N4● | IP20 | 100 | 0.1 | 1 | VW3A7730 | 1.500/ 3.307 |
| ATV340U15...U30N4● | IP20 | 100 | 0.26 | 1 | VW3A7740 | 2.500/ 5.512 |
| ATV340U40...U55N4● | IP20 | 60 | 0.5 | 1 | VW3A7741 | 4.500/ 9.921 |
| ATV340U75...D11N4● | IP20 | 28 | 1.1 | 1 | VW3A7742 | 4.000/ 8.818 |
| ATV340D15...D22N4● | IP20 | 16 | 2.2 | 1 | VW3A7743 | 7.000/ 15.432 |
| ATV340D30...D37N4● | IP20 | 10 | 2.9 | 1 | VW3A7744 | 11.500/ 25.353 |
| ATV340D45N4● | IP23 | 8 | 3.8 | 1 | VW3A7745 | 23.000/ 50.706 |
| ATV340D55...D75N4● | IP23 | 5 | 6.9 | 1 | VW3A7746 | 27.000/ 59.525 |

References for a severe braking cycle (hoisting applications)

| For drives | Degree of protection of the resistor | Ohmic value at 20 °C/ 68 °F | Average power available at 50 °C/ 122 °F (2) | Quantity required per drive | Reference | Weight |
|---|--------------------------------------|-----------------------------|--|-----------------------------|-----------|------------------|
| | | Ω | kW | | | kg/lb |
| Supply voltage: 380...480 V 50/60 Hz | | | | | | |
| ATV340U07...U30N4● | IP20 | 100 | 1.7 | 1 | VW3A7750 | 5.500/ 12.125 |
| ATV340U40...U55N4● | IP20 | 60 | 2.9 | 1 | VW3A7751 | 10.000/ 22.046 |
| ATV340U75...D11N4● | IP23 | 28 | 5.1 | 1 | VW3A7752 | 25.000/ 55.116 |
| ATV340D15...D22N4● | IP23 | 16 | 14 | 1 | VW3A7753 | 47.000/ 103.617 |
| ATV340D30...D37N4● | IP23 | 10 | 19 | 1 | VW3A7754 | 67.000/ 147.710 |
| ATV340D75N4● | IP23 | 10 | 19 | 2 | | |
| ATV340D45N4● | IP23 | 8 | 25 | 1 | VW3A7755 | 86.000/ 189.597 |
| ATV340D55N4● | IP23 | 5 | 32 | 1 | VW3A7756 | 120.000/ 264.554 |

(1) Load factor for resistors: The value of the average power that can be dissipated at 50 °C/122 °F from the resistor into the casing is determined for a load factor during braking that corresponds to the majority of normal applications:
 - Normal duty: 4 s braking with a 1.35 Tn braking torque for a 40 s cycle
 - Heavy duty: 4 s braking with a 1.65 Tn braking torque for a 40 s cycle
 (2) Load factor for resistors: The value of the average power that can be dissipated at 50 °C/122 °C from the resistor into the casing is determined for a load factor during braking that corresponds to the majority of normal applications:
 - Heavy duty: 54 s braking with a 1 Tn braking torque and 6 s braking with a 1.65 Tn braking torque for a 120 s cycle

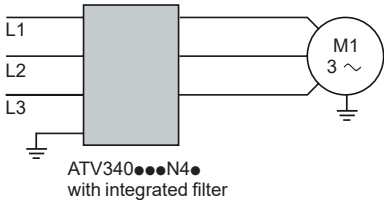

Altivar Machine drive ATV340 with integrated EMC filter

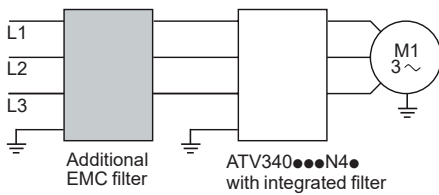

Altivar Machine drive ATV340 with additional EMC filter

Integrated EMC filters

Altivar Machine ATV340 drives have integrated radio interference input filters to comply with the EMC (electromagnetic compatibility) standard for variable speed electrical power drive products IEC 61800-3 category C2 or C3 and the European EMC Directive.

The integrated EMC filters comply with standard IEC 61800-3 for a maximum motor cable length listed below:

| | Maximum length of shielded cable acc. to | |
|---|--|----------------------------|
| | IEC/EN 61800-3 category C2 | IEC/EN 61800-3 category C3 |
| | For drivesm/ft | |
| Three-phase supply voltage: 380...480 V IP20 | | |
| ATV340U07...D22N4● | – | 20/66 |
| ATV340D30...D37N4E● | 50/164 | 100/328 |
| ATV340D45...D75N4E● | – | 100/328 |

Additional EMC input filters

The additional EMC input filters enable the drives to meet more stringent requirements; they are designed to reduce conducted emissions on the AC supply below the limits of standard IEC 61800-3 category C2 or C3 (see [page 52](#)).

Mounting on ATV340...N4●

Depending on the model, additional EMC filters can be mounted beside or underneath the drive.

Mounting the filter on the side of the drive: for ATV340U07...U75N4● drives

Mounting the filter underneath the drive: for ATV340D11...D22N4, ATV340D11...D75N4E, and ATV340D11...D22N4S drives

Use according to the type of AC supply

Additional EMC filters can only be used on TN (neutral connection) and TT (grounded neutral) type systems.

Standard IEC 61800-3, appendix D2.1, states that on IT systems (isolated or impedance grounded neutral), filters can cause permanent insulation monitors to operate in a random manner.

The effectiveness of additional filters on this type of system depends on the type of impedance between neutral and ground, and therefore cannot be predicted.

If a machine has to be installed on an IT system, one solution is to insert an isolation transformer and connect the machine locally on a TN or TT system.

Note:

ATV340U07...D22N4, ATV340U07...D37N4E●, and ATV340U07...D22N4S drives are compatible for use with maximum 100 m/328 ft shielded motor cable length with 4 kHz switching frequency.

ATV340D37...D75N4E● drives are compatible for use with maximum 100 m/328 ft shielded motor cable length with 2.5 kHz switching frequency.



VW3A4422



VW3A4706

| References | | | | | | |
|---|---|-------------|------------|----------------|--------------------------------------|------------------|
| For drives | Additional EMC input filter | | | | | |
| Reference | Maximum length of shielded cable (1) (2) IEC 61800-3 (5) | In (3) | Losses (4) | Filter mounted | Reference | Weight |
| | | | | | | |
| | m/ft | m/ft | A | W | | kg/lb |
| Three-phase supply voltage: 380...480 V 50/60 Hz | | | | | | |
| ATV340U07...U15N4● | 50/ 164 | 100/ 328 | 15 | 9.9 | On the side VW3A4422 | 0.600/ 1.323 |
| ATV340U22...U75N4● | 50/ 164 | 100/ 328 | 25 | 15.8 | On the side VW3A4423 | 0.775/ 1.709 |
| ATV340D11...D15N4● | 50/ 164 | 100/ 328 | 50 | 8 | On the side VW3A4711 | 5.200/ 11.464 |
| ATV340D18...D22N4● | 50/ 164 | 100/ 328 | 70 | 10 | On the side VW3A4712 | 6.100/ 13.448 |
| ATV340D30N4E● | 150/ 492 | 300/ 984 | 100 | 12.4 | On the side VW3A4706 | 6.500/ 14.330 |
| ATV340D37N4E● | 150/ 492 | 300/ 984 | 160 | 25 | On the side VW3A4707 | 8.500/ 18.739 |
| ATV340D45N4E● | 150/ 492 | 300/ 984 | 200 | 32.5 | On the side VW3A4708 | 9.500/ 20.944 |

(1) The filter selection tables give the maximum lengths for shielded cables connecting motors to drives. These maximum lengths are given as examples only, as they vary depending on the stray capacitance of the motors and the cables used. If motors are connected in parallel, it is the total length of all cables that should be taken into account.

(2) These values are given for a nominal switching frequency of 4 kHz.

(3) In: nominal filter current.

(4) Via heat dissipation, at the nominal filter current (In).

(5) Standard IEC 61800-3: EMC immunity and conducted and radiated EMC emissions:

- Category C2: public power supply (residential) and industrial power supply
- Category C3: industrial power supply

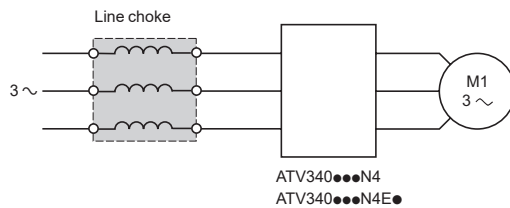

Presentation

Line chokes, also known as line reactors, provide improved immunity against overvoltages on the AC supply and can reduce harmonic distortion of the current produced by the drive.

The recommended chokes limit the input current. They have been developed in line with standard IEC 61800-5-1 (VDE 0160 level 1 high-energy overvoltages on the AC supply).

The inductance values are defined for a voltage drop between 3% and 5% of the nominal AC supply voltage. Values higher than this will cause loss of torque.

The use of line chokes is recommended in particular under the following circumstances:

- AC line supply with significant disturbance from other equipment (interference, overvoltages)
- AC line supply with voltage imbalance between phases > 1.8% of nominal voltage
- Drive supplied by an AC line supply with very low impedance (in the vicinity of a power transformer 10 times more powerful than the drive rating)
- Installation of a large number of frequency inverters on the same AC supply
- Reduction of overloads on the $\cos \varphi$ correction capacitors, if the installation includes a power factor correction unit

Line chokes are mandatory for variable speed drives ATV340U07...D22N4● operating in normal duty mode, and have to be ordered separately (see [page 54](#)). External line chokes are not required for variable speed drives ATV340D30...D75N4E●, in which integrated DC chokes serve for the same purpose.

Variable speed drives

Altivar Machine ATV340

Option: Line chokes



VW3A455●



VW3A456

| References | | | | | | | | | |
|---|-----------------|-------------|-----------------------------|------|--------------------------|------|------------|-----------|-------------------|
| Drive | | | | | | | Choke | | |
| Reference (3) | Operation mode | Motor power | Input current without choke | | Input current with choke | | Inductance | Reference | Weight |
| | | | U min. (1) U max. (1) | | U min. (1) U max. (1) | | | | |
| | | | kW | A | A | A | | | |
| Three-phase supply voltage: 380...480 V 50/60 Hz | | | | | | | | | |
| ATV340U07N4● | Heavy duty | 0.75 | 3.4 | 2.6 | 1.9 | 1.6 | 10 | VW3A4551 | 1.500/ 3.307 |
| | Normal duty (2) | 1.1 | – | – | 2.6 | 2.1 | 10 | VW3A4551 | 1.500/ 3.307 |
| ATV340U15N4● | Heavy duty | 1.5 | 6.0 | 4.9 | 3.5 | 2.8 | 10 | VW3A4551 | 1.500/ 3.307 |
| | Normal duty (2) | 2.2 | – | – | 5.1 | 4.1 | 4 | VW3A4552 | 3.000/ 6.613 |
| ATV340U22N4● | Heavy duty | 2.2 | 8.4 | 6.6 | 5.1 | 4.1 | 4 | VW3A4552 | 3.000/ 6.613 |
| | Normal duty (2) | 3 | – | – | 6.6 | 5.3 | 4 | VW3A4552 | 3.000/ 6.613 |
| ATV340U30N4● | Heavy duty | 3 | 10.7 | 8.5 | 6.6 | 5.3 | 4 | VW3A4552 | 3.000/ 6.613 |
| | Normal duty (2) | 4 | – | – | 8.6 | 6.8 | 4 | VW3A4552 | 3.000/ 6.613 |
| ATV340U40N4● | Heavy duty | 4 | 13.4 | 10.6 | 8.5 | 6.8 | 4 | VW3A4552 | 3.000/ 6.613 |
| | Normal duty (2) | 5.5 | – | – | 11.4 | 9.0 | 2 | VW3A4553 | 3.500/ 7.716 |
| ATV340U55N4● | Heavy duty | 5.5 | 20.0 | 16.0 | 11.6 | 9.4 | 2 | VW3A4553 | 3.500/ 7.716 |
| | Normal duty (2) | 7.5 | – | – | 15.3 | 12.2 | 2 | VW3A4553 | 3.500/ 7.716 |
| ATV340U75N4● | Heavy duty | 7.5 | 25.6 | 20.4 | 14.6 | 12.1 | 2 | VW3A4553 | 3.500/ 7.716 |
| | Normal duty (2) | 11 | – | – | 22.0 | 17.7 | 1 | VW3A4554 | 6.000/ 13.228 |
| ATV340D11N4● | Heavy duty | 11 | 34.7 | 27.7 | 21.9 | 17.7 | 1 | VW3A4554 | 6.000/ 13.228 |
| | Normal duty (2) | 15 | – | – | 28.8 | 23.0 | 1 | VW3A4554 | 6.000/ 13.228 |
| ATV340D15N4● | Heavy duty | 15 | 44.9 | 35.7 | 28.7 | 23.0 | 1 | VW3A4554 | 6.000/ 13.228 |
| | Normal duty (2) | 18.5 | – | – | 37.4 | 30.2 | 0.5 | VW3A4555 | 11.000/ 24.251 |
| ATV340D18N4● | Heavy duty | 18.5 | 54.7 | 43.4 | 37.2 | 30.1 | 0.5 | VW3A4555 | 11.000/ 24.251 |
| | Normal duty (2) | 22 | – | – | 43.4 | 35.0 | 0.5 | VW3A4555 | 11.000/ 24.251 |
| ATV340D22N4● | Heavy duty | 22 | 63.5 | 50.6 | 43.3 | 34.9 | 0.5 | VW3A4555 | 11.000/ 24.251 |
| | Normal duty (2) | 30 | – | – | 60.1 | 48.6 | 0.3 | VW3A4556 | 16.000/ 35.270 |

(1) Nominal supply voltage, U min = 380 V~, U max = 480 V~.

(2) A line choke is essential for the drive to operate in normal duty mode, so line current without choke is not applicable.

(3) For drives above 30 kW, ATV340D30N4E...D75N4E●, a DC choke is integrated, so an extra line choke is not required.

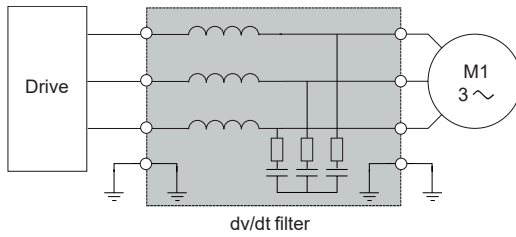

Altivar machine drive with dv/dt filter

Presentation

ATV340 drives with a supply voltage of 380...480 V operate with the following maximum motor cable lengths: 100 m/328 ft for unshielded/shielded cables. ATV340 drives rated more than 4 kW, with a supply voltage of 380...480 V operate with the following maximum motor cable lengths: 150 m/492 ft for shielded cables, 300 m/984 ft for unshielded cables.

To limit the impact of dv/dt and overvoltages in the motor, it is recommended that an output filter is added for cables longer than 50 m/164 ft if the motor insulation type does not conform to IEC 60034-25.

For further information, please consult the White Paper entitled “An Improved Approach for Connecting VSD and Electric Motors”.

Output filters are used to limit dv/dt at the motor terminals to 500 V/μs maximum for supply voltages up to 480 V.

Output filters are designed to limit overvoltages at the motor terminals to less than:

- 800 V with a shielded cable 0 to 50 m (0 to 164 ft) long, with a 400 V supply voltage
- 1,000 V with a shielded cable 50 to 150 m (164 to 492 ft) long, with a 400 V supply voltage
- 1,500 V with a shielded cable 150 to 300 m (492 to 984 ft) long, with a 400 V supply voltage (up to 500 m (1,640 ft) with an unshielded cable)

The performance of dv/dt filters will be affected if the maximum cable lengths are exceeded. For an application with several motors connected in parallel, the cable length must include all cabling. If a cable longer than that specified is used, the dv/dt filters may overheat.

The switching frequency must be under 8 kHz.

dv/dt output filters

| For drives | Maximum length of motor cable (1) | | Degree of protection (3) | In | Reference | Weight |
|--|-----------------------------------|------------|--------------------------|----|-----------|------------------------|
| | Maximum switching frequency (2) | Unshielded | | | | |
| | kHz | m/ft | m/ft | IP | A | kg/lb |
| Three-phase supply voltage: 380...480 V | | | | | | |
| ATV340U07...U15N4● | 4 | 300/984 | 300/984 | 20 | 6 | VW3A5301 11.000/24.251 |
| ATV340U22...U40N4● | 4 | 300/984 | 300/984 | 20 | 15 | VW3A5302 12.000/26.455 |
| ATV340U55...U75N4● | 4 | 500/1640 | 300/984 | 20 | 25 | VW3A5303 12.000/26.455 |
| ATV340D11...D18N4● | 4 | 500/1640 | 300/984 | 20 | 50 | VW3A5304 18.000/39.683 |
| ATV340D22N4● | 4 | 500/1640 | 300/984 | 20 | 95 | VW3A5305 19.000/41.888 |
| ATV340D30...D37N4E● | 4 | 500/1640 | 300/984 | 00 | 180 | VW3A5306 22.000/48.502 |

(1) Values given depend on the nominal switching frequency of the drive. This frequency depends on the drive rating. These cable lengths are given as examples only as they can vary depending on the application. They correspond to motors conforming to IEC 60034-25 and NEMA MG1/31.2006.

(2) The filters are designed to operate in a switching frequency range of between 2 and 8 kHz.

(3) Nominal filter current.

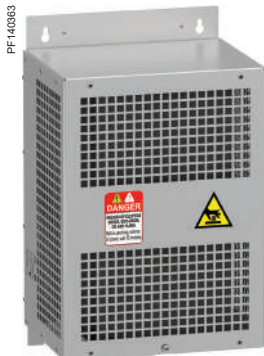

VW3A5301

Variable speed drives

Altivar Machine ATV340

Output filters

Option: dv/dt filters, common mode filters

Upgrade from ATV71 to ATV 340: combination table

| Old drive: ATV71 | Old accessory: motor choke (1) | New drive: ATV340 | New accessory: dv/dt filter |
|--|--------------------------------------|---|-----------------------------------|
| ATV71H075N4...HU15N4 ATV71W075N4...WU15N4 ATV71P075N4Z...PU15N4Z | VW3A5101... VW3A5103 | ATV340U07...U15N4 ATV340U07...U15N4E | VW3A5301 |
| ATV71HU22N4...HU40N4 ATV71WU22N4...WU40N4 ATV71PU22N4Z...PU40N4Z | VW3A5101... VW3A5103 | ATV340U22...U40N4 ATV340U22...U40N4E | VW3A5302 |
| ATV71HU55N4...HU75N4 ATV71WU55N4...WU75N4 | VW3A5102... VW3A5104 | ATV340U55...U75N4 ATV340U55...U75N4E | VW3A5303 |
| ATV71HD11N4...HD18N4 ATV71WD11N4...WD18N4 | VW3A5102... VW3A5104 | ATV340D11...D18N4 ATV340D11...D18N4E | VW3A5304 |
| ATV71HD22N4...HD37N4 ATV71WD22N4...WD37N4 | VW3A5103... VW3A5104 | ATV340D22N4 ATV340D22...D37N4E● | VW3A5305 |
| ATV71HD45N4...HD75N4 ATV71WD45N4...WD75N4 | VW3A5104 | ATV340D45...D75N4E● | VW3A5306 |

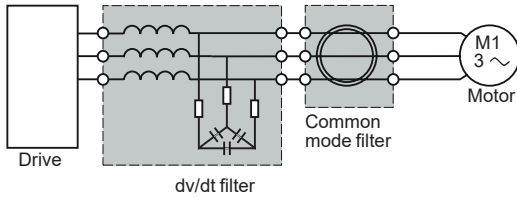

ATV340 drive with common mode filter

Presentation

dv/dt filters reduce the overvoltage across windings and high frequency currents in differential mode. But they have no effect on the common mode current between phases and the cable shielding, and between the windings and the stator/rotor of the motor.

Common mode filters bring several benefits:

- Reduction of RFI (radio frequency interference) of the motor cable and improvement of the effectiveness of the EMC filter for conducted emissions
- Reduction of the high frequency currents circulating in the bearings of the motor and prevention of their damage

It is possible to use the common mode filter or the dv/dt filter at the output terminals of the drive.

Note: The selection of a common mode configuration depends on the type and length of motor cable. An abnormal increase in temperature indicates a possible saturation. Additional filters should be used to avoid it.

Common mode filters

| For drives | Maximum length of unshielded cable | | |
|---------------------|------------------------------------|---------------------|------------------------|
| | 100 m/492 ft | 300 m/984 ft (2) | 500 m/1,640 ft (2) |
| ATV340U07...U40N4● | VW3A5502 | 2 x VW3A5501 | - |
| ATV340U55...U75N4● | VW3A5501 | VW3A5502 | VW3A5501 + VW3A5502 |
| ATV340D11...D22N4● | VW3A5503 | VW3A5504 | 2 x VW3A5503 |
| ATV340D30...D75N4E● | VW3A5503 | VW3A5504 | VW3A5503 + VW3A5504 |

| For drives | Maximum length of shielded cable | |
|---------------------|----------------------------------|------------------------|
| | 100 m/492 ft | 300 m/984 ft (2) |
| ATV340U07...U40N4● | VW3A5502 | 2 x VW3A5501 |
| ATV340U55...U75N4● | VW3A5502 | 2 x VW3A5501 |
| ATV340D11...D22N4● | VW3A5503 | 2 x VW3A5503 |
| ATV340D30...D75N4E● | VW3A5504 | VW3A5503 + VW3A5504 |

(1) Refer to the [ATV71 catalog](#) for corresponding shielded/unshielded motor cable length and switching frequency.

(2) With dv/dt filter

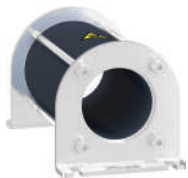

VW3A5501

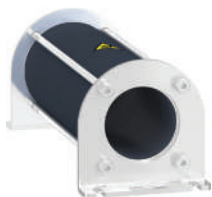

VW3A5502

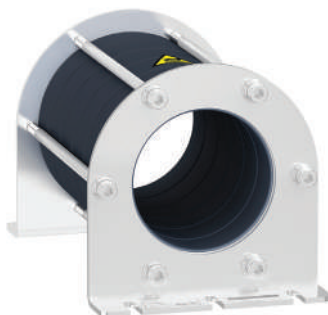

VW3A5504

Variable speed drives

Altivar Machine ATV340

Option: ATV Regenerative units



ATVRD15N4



ATVRU75N4

Presentation

The main function of the ATV Regen product is to provide an option to regenerate energy back to the AC supply for heavy braking applications such as material working, material handling, and hoisting with easy configuration.

This option should be associated with Altivar drives in the 400 V series such as Altivar 340. The braking unit harmonic performance is the same as that of standard drives.

Features:

- Chemical class 3C3 conforming to IEC/EN 60721
- Mechanical class 3S2 conforming to IEC/EN 60721
- -10..50 °C/14...122 °F without derating, up to 60 °C/140 °F with derating
- Mechanical class 3S2 conforming to IEC/EN 60721
- Built in EMC filter comply with standard IEC 61800-3

Wiring concept

Generic wiring

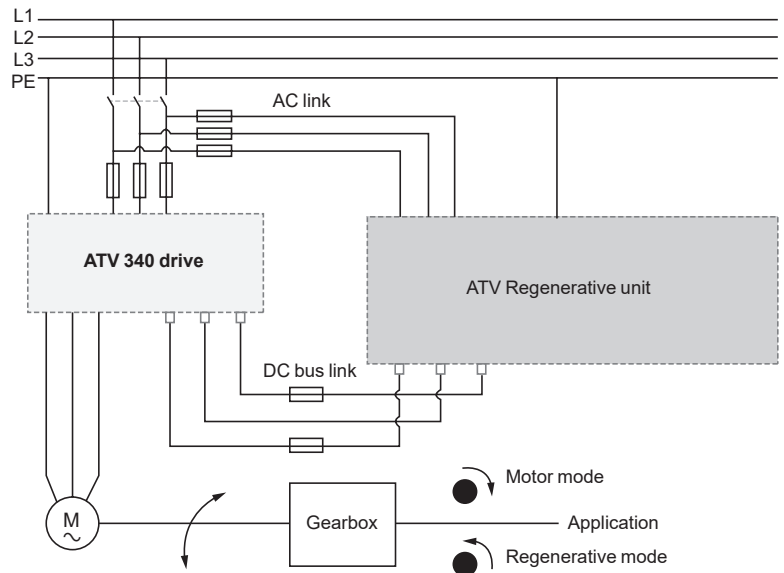

One drive for several Regenerative units

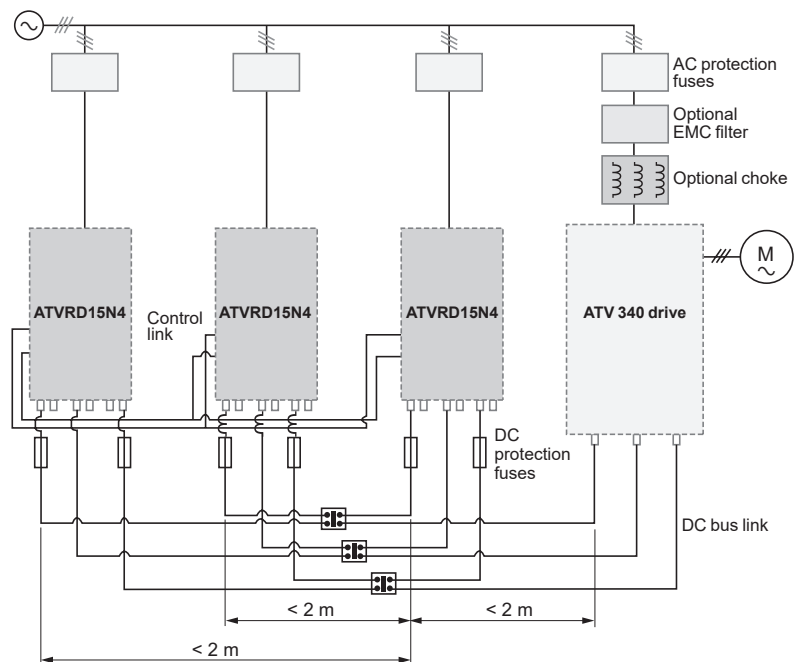



[Click to download
Altivar Regenerative Unit: Sizing Tool](#)

Wiring concept (continued)

Several drives with one Regenerative unit

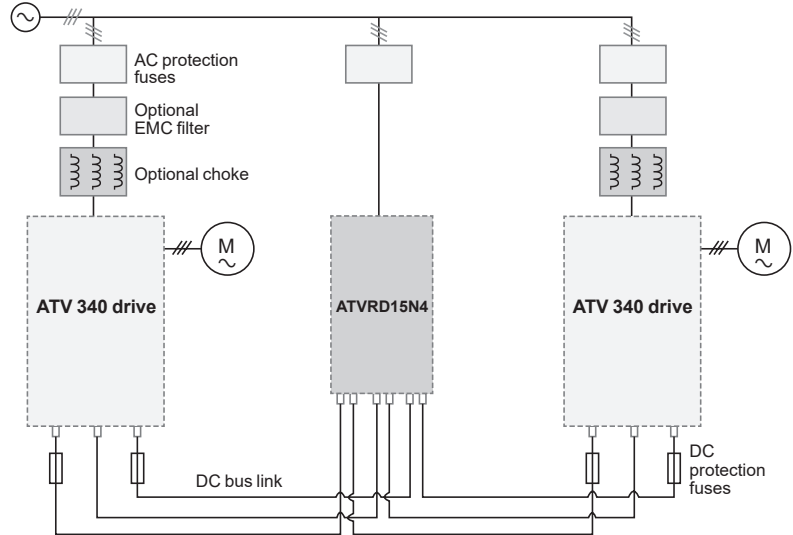

References

| For drives (1) | IP | Regenerative unit reference | Weight kg/ lb |
|---|----|--------------------------------|---------------------|
| Supply voltage: 380...480 V 50/60 Hz | | | |
| ATV340U07...D22N4● ATV340D30...D37N4E● | 20 | ATVRU75N4 | 6.000/ 13.228 |
| ATV340D11...D22N4 ATV340D30...D75N4E● | 20 | ATVRD15N4 | 11.500/ 25.353 |

(1) For sizing, refer to the [Altivar Regenerative Unit User Manual](#).

Applications

Circuit breaker/contactor/drive combinations help to ensure continuity of service in the installation.

The type of circuit breaker/contactor coordination selected can reduce maintenance costs in the event of a short-circuit on the drive input by minimizing the time required to make the necessary repairs and the cost of replacement equipment. The suggested combinations provide coordination according to the drive rating.

The drive controls the motor, provides a monitoring function against short-circuits between the drive and the motor, and helps protect the motor cable against overloads. Overload monitoring is provided by the drive's motor thermal monitoring function if this has been enabled. Otherwise, an external monitoring device such as a probe or thermal overload relay should be provided.

The circuit breaker helps protect the drive's power cables against short-circuits.

IEC standard motor starters

| Motor | Drive | Circuit breaker | | Line contactor |
|---|-----------|-----------------|--------------|-------------------|
| Power (1) | Reference | Reference (2) | Rating | Reference (3) (4) |
| kW | HP | | A | |
| Three-phase supply voltage: 380...415 V 50/60 Hz | | | | |
| 0.75 | 1 | ATV340U07N4● | GV2L08 | LC1D09●● |
| 1.5 | 2 | ATV340U15N4● | GV2L10 | LC1D09●● |
| 2.2 | 3 | ATV340U22N4● | GV2L14 | LC1D09●● |
| 3 | 4 | ATV340U30N4● | GV2L16 | LC1D18●● |
| 4 | 5 | ATV340U40N4● | | |
| 5.5 | 7.5 | ATV340U55N4● | GV2L22 | LC1D25●● |
| 7.5 | 10 | ATV340U75N4● | GV3L32 | LC1D40A●● |
| 11 | 15 | ATV340D11N4● | GV3L40 | LC1D40A●● |
| 15 | 20 | ATV340D15N4● | GV3L50 | LC1D50A●● |
| 18.5 | 25 | ATV340D18N4● | GV3L65 | LC1D65A●● |
| 22 | 30 | ATV340D22N4● | | |
| 30 | 40 | ATV340D30N4E● | GV4L/LE80● | LC1D65A●● |
| 37 | 50 | ATV340D37N4E● | | LC1D80●● |
| 45 | 60 | ATV340D45N4E● | GV4L/LE115● | LC1D115●● |
| 55 | 75 | ATV340D55N4E● | | |
| 75 | 100 | ATV340D75N4E● | NSX250●MA220 | LC1G185●●●● |

(1) Standard power ratings for 400 V 50/60 Hz 4-pole motors.

The values expressed in HP conform to the NEC (National Electrical Code).

(2) For references to be completed, replace the dot with the letter corresponding to the breaking performance of the circuit breaker (B, F, N, H, S, or L).

Breaking capacity of circuit breakers according to standard IEC 60947-2:

| Circuit breaker | Icu (kA) for 380...415 V | Icu (kA) for 380...415 V | | | | | |
|------------------|--------------------------|--------------------------|----|----|----|-----|-----|
| | | B | F | N | H | S | L |
| GV2L08...L14 | 100 | – | – | – | – | – | – |
| GV2L16...L22 | 50 | – | – | – | – | – | – |
| GV3L32...L65 | 50 | – | – | – | – | – | – |
| GV4L/LE80...115● | – | 25 | – | 50 | – | 100 | – |
| NSX250●MA220 | – | – | 36 | 50 | 70 | 100 | 150 |

(3) Composition of contactors:

LC1D09...D115: 3 poles + 1 NO auxiliary contact + 1 NC auxiliary contact

LC1F185: 3 poles

To add auxiliary contacts or other accessories, please refer to the [TeSys - Motor control and protection components catalog](#).

(4) Replace ●● or ●●●● with the control circuit voltage code indicated in the table below:

| | Volts ~ | 24 | 48 | 110 | 220 | 230 | 240 |
|---------------|----------|---------|----|----------|-----------|-----------|-----|
| LC1D09...D115 | 50 Hz | B5 | E5 | F5 | M5 | P5 | U5 |
| | 60 Hz | B6 | E6 | F6 | M6 | – | U6 |
| | 50/60 Hz | B7 | E7 | F7 | M7 | P7 | U7 |
| LC1G185 | Volts ~ | 24...48 | | 48...130 | 110...250 | 200...500 | |
| | | BEEA | | EHEN | KUEN | LSEA | |

For other voltages available between 24 V ~ and 660 V ~, or a DC control circuit, please contact our Customer Care Center.



GV3L65

+



LC1D65A●●

+



ATV340D22N4S



GV4L80●●

+



LC1D80●●

+



ATV340D45N4E

| IEC standard motor starters | | | | | | |
|--|-----------|-----------------|--------------|-----------------|-------------------|-----------|
| Motor | Drive | Circuit breaker | | | Line contactor | |
| Power (1) | Reference | Reference (2) | Rating | I _{rm} | Reference (3) (4) | |
| kW | HP | | A | A | | |
| Three-phase supply voltage: 440 V 50/60 Hz | | | | | | |
| 0.75 | 1 | ATV340U07N4● | GV2L08 | 4 | 51 | LC1D09●● |
| 1.5 | 2 | ATV340U15N4● | GV2L10 | 6.3 | 78 | LC1D09●● |
| 2.2 | 3 | ATV340U22N4● | GV2L14 | 10 | 138 | LC1D09●● |
| 3 | 4 | ATV340U30N4● | | | | LC1D18●● |
| 4 | 5 | ATV340U40N4● | GV2L16 | 14 | 170 | LC1D18●● |
| 5.5 | 7.5 | ATV340U55N4● | GV2L20 | 18 | 223 | LC1D25●● |
| 7.5 | 10 | ATV340U75N4● | GV3L25 | 25 | 350 | LC1D32●● |
| 11 | 15 | ATV340D11N4● | GV3L32 | 32 | 448 | LC1D40A●● |
| 15 | 20 | ATV340D15N4● | GV3L50 | 50 | 700 | LC1D50A●● |
| 18.5 | 25 | ATV340D18N4● | | | | |
| 22 | 30 | ATV340D22N4● | | | | |
| 30 | 40 | ATV340D30N4E● | GV3L65 | 65 | 910 | LC1D65A●● |
| 37 | 50 | ATV340D37N4E● | GV4L/LE80● | 80 | 1040 | LC1D65A●● |
| 45 | 60 | ATV340D45N4E● | | | | LC1D80●● |
| 55 | 75 | ATV340D55N4E● | GV4L/LE115● | 115 | 1495 | LC1D115●● |
| 75 | 100 | ATV340D75N4E● | NSX160●MA150 | 150 | 1500 | LC1D115●● |

(1) Standard power ratings for 400 V 50/60 Hz 4-pole motors.

The values expressed in HP conform to the NEC (National Electrical Code).

(2) For references to be completed, replace the dot with the letter corresponding to the breaking performance of the circuit breaker (B, F, N, H, S, or L). Breaking capacity of circuit breakers according to standard IEC 60947-2:

| Circuit breaker | I _{cu} (kA) for 440 V | I _{cu} (kA) for 440 V | | | | | |
|-----------------|--------------------------------|--------------------------------|----|----|----|----|-----|
| | | B | F | N | H | S | L |
| GV2L08...L10 | 100 | – | – | – | – | – | – |
| GV2L14...L20 | 20 | – | – | – | – | – | – |
| GV3L25...L65 | 50 | – | – | – | – | – | – |
| GV4L/LE80...115 | – | 20 | – | 50 | – | 70 | – |
| NSX160●MA150 | – | – | 35 | 50 | 65 | 90 | 130 |

(3) Composition of contactors:

LC1D09...D115: 3 poles + 1 NO auxiliary contact + 1 NC auxiliary contact

To add auxiliary contacts or other accessories, please refer to the [TeSys - Motor control and protection components catalog](#).

(4) Replace ●● with the control circuit voltage code indicated in the table below:

| LC1D09...D115 | Volts ~ | 24 | 48 | 110 | 220 | 230 | 240 |
|---------------|---------|----|----|-----|-----|-----|-----|
| | 50 Hz | B5 | E5 | F5 | M5 | P5 | U5 |
| 60 Hz | B6 | E6 | F6 | M6 | – | U6 | |
| 50/60 Hz | B7 | E7 | F7 | M7 | P7 | U7 | |

For other voltages available between 24 V ~ and 660 V ~, or a DC control circuit, please contact our Customer Care Center.

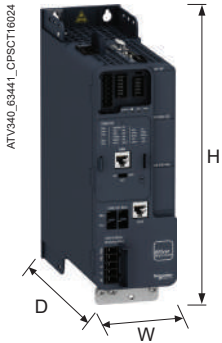

Modular drives

Three-phase supply voltage: 380...480 V 50/60 Hz

Overall dimensions

| Drives | W x H x D (1) | |
|----------------|------------------|---------------------|
| | mm | in. |
| ATV340U07N4 | 85 x 270 x 232.5 | 3.35 x 10.63 x 9.15 |
| With EMC plate | 85 x 398 x 232.5 | 3.35 x 15.67 x 9.15 |
| ATV340U15N4 | 85 x 270 x 232.5 | 3.35 x 10.63 x 9.15 |
| With EMC plate | 85 x 398 x 232.5 | 3.35 x 15.67 x 9.15 |
| ATV340U22N4 | 85 x 270 x 232.5 | 3.35 x 10.63 x 9.15 |
| With EMC plate | 85 x 398 x 232.5 | 3.35 x 15.67 x 9.15 |
| ATV340U30N4 | 85 x 270 x 232.5 | 3.35 x 10.63 x 9.15 |
| With EMC plate | 85 x 398 x 232.5 | 3.35 x 15.67 x 9.15 |
| ATV340U40N4 | 85 x 270 x 232.5 | 3.35 x 10.63 x 9.15 |
| With EMC plate | 85 x 398 x 232.5 | 3.35 x 15.67 x 9.15 |
| ATV340U55N4 | 110 x 270 x 234 | 4.33 x 10.63 x 9.21 |
| With EMC plate | 110 x 398 x 234 | 4.33 x 15.67 x 9.21 |
| ATV340U75N4 | 110 x 270 x 234 | 4.33 x 10.63 x 9.21 |
| With EMC plate | 110 x 398 x 234 | 4.33 x 15.67 x 9.21 |
| ATV340D11N4 | 180 x 385 x 249 | 7.09 x 15.16 x 9.80 |
| With EMC plate | 180 x 541 x 249 | 7.09 x 21.30 x 9.80 |
| ATV340D15N4 | 180 x 385 x 249 | 7.09 x 15.16 x 9.80 |
| With EMC plate | 180 x 541 x 249 | 7.09 x 21.30 x 9.80 |
| ATV340D18N4 | 180 x 385 x 249 | 7.09 x 15.16 x 9.80 |
| With EMC plate | 180 x 541 x 249 | 7.09 x 21.30 x 9.80 |
| ATV340D22N4 | 180 x 385 x 249 | 7.09 x 15.16 x 9.80 |
| With EMC plate | 180 x 541 x 249 | 7.09 x 21.30 x 9.80 |

(1) The total depth excludes the option modules, + 20 mm/0.79 in. depth if combined with the option module. For a cabinet installation that uses front wiring for an option module, + 60 mm/2.36 in. depth is required. Front wiring used for ATV340U07...D22N4 drives.

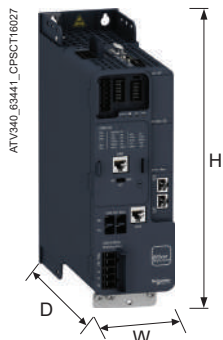

Ethernet-embedded drives
Three-phase supply voltage: 380...480 V 50/60 Hz

Overall dimensions

| Drives | W x H x D | |
|----------------|------------------|-----------------------|
| | mm | in. |
| ATV340U07N4E | 85 x 270 x 232.5 | 3.35 x 10.63 x 9.15 |
| With EMC plate | 85 x 398 x 232.5 | 3.35 x 15.67 x 9.15 |
| ATV340U15N4E | 85 x 270 x 232.5 | 3.35 x 10.63 x 9.15 |
| With EMC plate | 85 x 398 x 232.5 | 3.35 x 15.67 x 9.15 |
| ATV340U22N4E | 85 x 270 x 232.5 | 3.35 x 10.63 x 9.15 |
| With EMC plate | 85 x 398 x 232.5 | 3.35 x 15.67 x 9.15 |
| ATV340U30N4E | 85 x 270 x 232.5 | 3.35 x 10.63 x 9.15 |
| With EMC plate | 85 x 398 x 232.5 | 3.35 x 15.67 x 9.15 |
| ATV340U40N4E | 85 x 270 x 232.5 | 3.35 x 10.63 x 9.15 |
| With EMC plate | 85 x 398 x 232.5 | 3.35 x 15.67 x 9.15 |
| ATV340U55N4E | 110 x 270 x 234 | 4.33 x 10.63 x 9.21 |
| With EMC plate | 110 x 398 x 234 | 4.33 x 15.67 x 9.21 |
| ATV340U75N4E | 110 x 270 x 234 | 4.33 x 10.63 x 9.21 |
| With EMC plate | 110 x 398 x 234 | 4.33 x 15.67 x 9.21 |
| ATV340D11N4E | 180 x 385 x 249 | 7.09 x 15.16 x 9.80 |
| With EMC plate | 180 x 541 x 249 | 7.09 x 21.30 x 9.80 |
| ATV340D15N4E | 180 x 385 x 249 | 7.09 x 15.16 x 9.80 |
| With EMC plate | 180 x 541 x 249 | 7.09 x 21.30 x 9.80 |
| ATV340D18N4E | 180 x 385 x 249 | 7.09 x 15.16 x 9.80 |
| With EMC plate | 180 x 541 x 249 | 7.09 x 21.30 x 9.80 |
| ATV340D22N4E | 180 x 385 x 249 | 7.09 x 15.16 x 9.80 |
| With EMC plate | 180 x 541 x 249 | 7.09 x 21.30 x 9.80 |
| ATV340D30N4E | 213 x 660 x 262 | 8.39 x 25.98 x 10.31 |
| ATV340D37N4E | 213 x 660 x 262 | 8.39 x 25.98 x 10.31 |
| ATV340D45N4E | 271 x 908 x 309 | 10.67 x 35.75 x 12.17 |
| ATV340D55N4E | 271 x 908 x 309 | 10.67 x 35.75 x 12.17 |
| ATV340D75N4E | 271 x 908 x 309 | 10.67 x 35.75 x 12.17 |

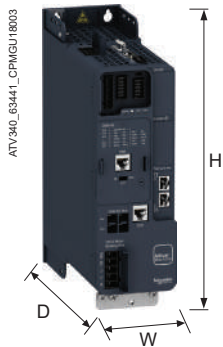

Ethernet drive for cabinet integration
Three-phase supply voltage: 380...480 V 50/60 Hz

| Overall dimensions | | |
|--------------------|-----------------|-----------------------|
| Drives | W x H x D | |
| | mm | in. |
| ATV340D30N4EZ | 210 x 597x 262 | 8.3 x 23.5x 10.31 |
| ATV340D37N4EZ | 210 x 597x 262 | 8.3 x 23.5x 10.31 |
| ATV340D45N4EZ | 265 x 748 x 307 | 10.43 x 29.45 x 12.08 |
| ATV340D55N4EZ | 265 x 748 x 307 | 10.43 x 29.45 x 12.08 |
| ATV340D75N4EZ | 265 x 748 x 307 | 10.43 x 29.45 x 12.08 |

Sercos-embedded drives
Three-phase supply voltage: 380...480 V 50/60 Hz

| Overall dimensions | | |
|--------------------|------------------|---------------------|
| Drives | W x H x D | |
| | mm | in. |
| ATV340U07N4S | 85 x 270 x 232.5 | 3.35 x 10.63 x 9.15 |
| With EMC plate | 85 x 398 x 232.5 | 3.35 x 15.67 x 9.15 |
| ATV340U15N4S | 85 x 270 x 232.5 | 3.35 x 10.63 x 9.15 |
| With EMC plate | 85 x 398 x 232.5 | 3.35 x 15.67 x 9.15 |
| ATV340U22N4S | 85 x 270 x 232.5 | 3.35 x 10.63 x 9.15 |
| With EMC plate | 85 x 398 x 232.5 | 3.35 x 15.67 x 9.15 |
| ATV340U30N4S | 85 x 270 x 232.5 | 3.35 x 10.63 x 9.15 |
| With EMC plate | 85 x 398 x 232.5 | 3.35 x 15.67 x 9.15 |
| ATV340U40N4S | 85 x 270 x 232.5 | 3.35 x 10.63 x 9.15 |
| With EMC plate | 85 x 398 x 232.5 | 3.35 x 15.67 x 9.15 |
| ATV340U55N4S | 110 x 270 x 234 | 4.33 x 10.63 x 9.21 |
| With EMC plate | 110 x 398 x 234 | 4.33 x 15.67 x 9.21 |
| ATV340U75N4S | 110 x 270 x 234 | 4.33 x 10.63 x 9.21 |
| With EMC plate | 110 x 398 x 234 | 4.33 x 15.67 x 9.21 |
| ATV340D11N4S | 180 x 385 x 249 | 7.09 x 15.16 x 9.80 |
| With EMC plate | 180 x 541 x 249 | 7.09 x 21.30 x 9.80 |
| ATV340D15N4S | 180 x 385 x 249 | 7.09 x 15.16 x 9.80 |
| With EMC plate | 180 x 541 x 249 | 7.09 x 21.30 x 9.80 |
| ATV340D18N4S | 180 x 385 x 249 | 7.09 x 15.16 x 9.80 |
| With EMC plate | 180 x 541 x 249 | 7.09 x 21.30 x 9.80 |
| ATV340D22N4S | 180 x 385 x 249 | 7.09 x 15.16 x 9.80 |
| With EMC plate | 180 x 541 x 249 | 7.09 x 21.30 x 9.80 |

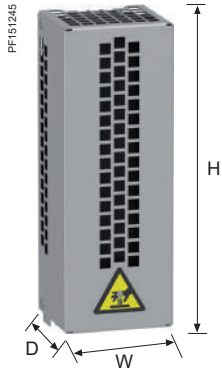

Braking resistors

Overall dimensions

| Braking resistors | W x H x D | |
|-------------------|-------------------|-----------------------|
| | mm | in. |
| VW3A7730 | 105 x 295 x 100 | 4.13 x 11.61 x 3.94 |
| VW3A7731 | 105 x 345 x 100 | 4.13 x 13.58 x 3.94 |
| VW3A7732 | 175 x 345 x 100 | 6.89 x 13.58 x 3.94 |
| VW3A7733 | 190 x 570 x 180 | 7.48 x 22.44 x 7.09 |
| VW3A7734 | 250 x 490 x 180 | 9.84 x 19.29 x 7.09 |
| VW3A7735 | 250 x 490 x 180 | 9.84 x 19.29 x 7.09 |
| VW3A7736 | 485 x 410 x 485 | 19.09 x 16.14 x 19.09 |
| VW3A7740 | 105 x 465 x 100 | 4.13 x 18.31 x 3.94 |
| VW3A7741 | 175 x 465 x 100 | 6.89 x 18.31 x 3.94 |
| VW3A7742 | 190 x 570 x 180 | 7.48 x 22.44 x 7.09 |
| VW3A7743 | 290 x 570 x 180 | 11.42 x 22.44 x 7.09 |
| VW3A7744 | 450 x 490 x 180 | 17.72 x 19.29 x 7.09 |
| VW3A7745 | 485 x 610 x 485 | 19.09 x 24.02 x 19.09 |
| VW3A7746 | 485 x 610 x 485 | 19.09 x 24.02 x 19.09 |
| VW3A7750 | 290 x 570 x 180 | 11.42 x 22.44 x 7.09 |
| VW3A7751 | 390 x 570 x 180 | 15.35 x 22.44 x 7.09 |
| VW3A7752 | 485 x 610 x 485 | 19.09 x 24.02 x 19.09 |
| VW3A7753 | 485 x 1020 x 605 | 19.09 x 40.16 x 23.82 |
| VW3A7754 | 485 x 820 x 1035 | 19.09 x 32.28 x 40.75 |
| VW3A7755 | 485 x 1020 x 1035 | 19.09 x 40.16 x 40.75 |
| VW3A7756 | 485 x 1020 x 1285 | 19.09 x 40.16 x 50.59 |

ATV Regenerative units

Overall dimensions

| ATV Regenerative units | W x H x D | |
|------------------------|-----------------|---------------------|
| | mm | in. |
| ATVRD15N4 | 105 x 399 x 235 | 4.13 x 15.71 x 9.25 |
| ATVRU75N4 | 80 x 337 x 175 | 3.15 x 13.27 x 6.89 |

Additional EMC filters

Overall dimensions

| EMC filters | W x H x D | |
|-------------|-----------------|----------------------|
| | mm | in. |
| VW3A4422 | 107 x 195 x 42 | 4.21 x 7.68 x 1.65 |
| VW3A4423 | 140 x 235 x 50 | 5.51 x 9.25 x 1.97 |
| VW3A4706 | 120 x 340 x 180 | 4.72 x 13.39 x 7.09 |
| VW3A4707 | 130 x 395 x 240 | 5.12 x 15.55 x 9.45 |
| VW3A4708 | 200 x 445 x 320 | 7.87 x 17.52 x 12.60 |
| VW3A4711 | 90 x 285 x 170 | 3.54 x 11.22 x 6.69 |
| VW3A4712 | 100 x 330 x 180 | 3.94 x 12.99 x 7.09 |

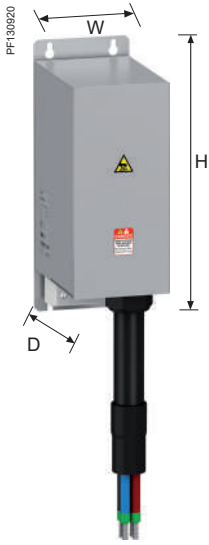

Line chokes

Overall dimensions

| Motor chokes | W x H x D | |
|--------------|-----------------|---------------------|
| | mm | in. |
| VW3A4551 | 100 x 135 x 60 | 3.94 x 5.31 x 2.36 |
| VW3A4552 | 130 x 155 x 90 | 5.12 x 6.10 x 3.54 |
| VW3A4553 | 130 x 155 x 90 | 5.12 x 6.10 x 3.54 |
| VW3A4554 | 155 x 170 x 135 | 6.10 x 6.69 x 5.31 |
| VW3A4555 | 180 x 210 x 165 | 7.09 x 8.27 x 6.50 |
| VW3A4556 | 270 x 210 x 180 | 10.63 x 8.27 x 7.09 |

dv/dt filters

Overall dimensions

| dv/dt filters | W x H x D | |
|---------------|-----------------|-----------------------|
| | mm | in. |
| VW3A5301 | 295 x 535 x 215 | 11.61 x 21.06 x 8.17 |
| VW3A5302 | 295 x 535 x 215 | 11.61 x 21.06 x 8.17 |
| VW3A5303 | 295 x 535 x 215 | 11.61 x 21.06 x 8.17 |
| VW3A5304 | 300 x 560 x 245 | 11.44 x 21.32 x 9.35 |
| VW3A5305 | 300 x 610 x 245 | 11.44 x 23.09 x 9.35 |
| VW3A5306 | 380 x 350 x 235 | 14.57 x 13.77 x 12.43 |

Common mode filters

Overall dimensions

| Common mode filters | W x H x D | |
|---------------------|---------------------|--------------------|
| | mm | in. |
| VW3A5501 | 66 x 119.2 x 66 | 2.60 x 4.69 x 2.60 |
| VW3A5502 | 66 x 163.8 x 66 | 2.60 x 6.45 x 2.60 |
| VW3A5503 | 127.5 x 161 x 127.5 | 5.02 x 6.34 x 5.02 |
| VW3A5504 | 127.5 x 210 x 127.5 | 5.02 x 8.27 x 5.02 |

Variable speed drives and soft starters

A whole world of Services for your drives and soft starters by Schneider Electric



Support and services offer by Schneider Electric

Variable speed drives and soft starters are an important part of your operation, with downtime having a significant impact on your business. Protecting that investment through comprehensive services means that you can continue to deliver optimally throughout the lifecycle of your drive and soft starter. Our range of services is designed to help you get more out of your drives and soft starters, your operation, and to improve your environmental impact.



Install

- **Extended Warranty** service helps you control your maintenance costs. Schneider Electric will provide a replacement drive and soft starter or repair the product on site during a period of one or three years more than the standard warranty, in all conditions covered by the extended warranty.
- **Start-up** service is the first essential step in maintenance and optimal operational performance of the drive or soft starter. Our comprehensive review checks up to 100 parameters and is especially designed for drives and soft starters in simple applications.
- **Commissioning** service ensures a reliable start for operations with more complex applications and drive systems. The unique requirements of your process need to be carefully considered to ensure efficient operations.

Operate

- **Preventive Maintenance** service performs predetermined maintenance actions according to a product-specific schedule. The work is carried out by certified technical experts following Schneider Electric instructions. This service minimizes unplanned downtime and extends your equipment lifetime.
- **Remote Technical Support** brings you expert product assistance over the phone, email, chat, or web for any technical questions relating to your drives and soft starters, including configuration, diagnostics, and maintenance. Our global support team is multi-lingual with support available up to R&D level experts if needed.
- **On-Site Expert Assistance** service offers you highly skilled field service experts to troubleshoot and resolve drive or soft starter equipment-related matters at your site, as a back-up source of expertise for your personnel.
- **Spare Part Management** service identifies and manages your critical spare parts either on your site or offsite. This service ensures that you have access to the spares you need without having to invest in capital to maintain the stock.

(1) Services available in countries that have the right structure and capabilities.

Variable speed drives and soft starters

A whole world of Services for your drives and soft starters by Schneider Electric



Support and services offer by Schneider Electric (continued)

Optimize

- **Training** service offers eLearning, classroom, and onsite training provision to enhance the technical installation, commissioning, and maintenance competencies of your personnel. Added competence translates into further process efficiency and reliability, as well as employee satisfaction.
- **EcoStruxure Asset Advisor** service enables you to move from reactive to predictive maintenance and access actionable insight provided by the advisor. The service predicts drive- and motor-related actions through connected devices and advanced algorithms monitored by Schneider Electric's experts.

Renew

- **Drive Revitalization** is an excellent choice if you prefer to use your aging drives longer and want to extend their service life with affordable and comprehensive inspection and replacement of all critical parts.
- **Drive and soft starter replacement** involves modernizing equipment by replacing the previous aged or obsolete product with a new one matched to the purpose. The service can be extended with engineering in case the device and process requires more advanced engineering.

Circular economy

- **Spare Parts** are available from our local, regional, and global stocks. Original equipment parts from Schneider Electric are reliable and easily available. They will help to keep your product in operation for longer.
- **Repair** allows you to extend the life of your drive or soft starter. The affected product can be replaced, or repaired on site or at our repair centers, depending on the type of product in question.
- **Fast Exchange by refurbished drive or soft starter (1)** gives a second life to inoperative drives or soft starters. In this case, we offer an immediate exchange with a replacement refurbished drive or soft starter and take back the product, repair it, and keep it ready for the next exchange.
- **Take-back and recycling (1)** is the last step to improve your environmental impact. Unrepairable products are dismantled, raw materials are collected and given a second life. Up to 85% of the product components can be recycled.

Service contracts secure recovery, availability, and outcome

Service contracts manage the safety and performance of your assets through well-defined maintenance plans tailored to your operational needs. The predefined service contract – Advantage Service Plan – and fully customizable “à la carte” service contract are built from the services in the “Operate” and “Optimize” phases and service levels defining availability, response, and lead times matching your particular needs. You will enjoy priority access to Schneider Electric support when you need it, as well as having an expert partner to plan the long-term evolution of your drives and soft starters.

mySchneider app

With the mySchneider app you have easy 24/7 access to product information and expert support. All registered users have access to additional features, such as real-time notifications, order tracking, product pricing, and availability. The mySchneider app is available for download from the IOS and Android app store.

Schneider Electric – helping you succeed

Schneider Electric, the leader in digital transformation of energy management and automation, has operations in more than 100 countries. With this global footprint we have certified field service representatives, regional expert and advanced level support up to product R&D to provide you the right support across the lifecycle of your drives and soft starters. Furthermore, we offer an extensive network of local and global repair centers and a logistics chain that underpins our ability to respond to your needs.

To order services or find out more, please contact your local Schneider Electric service center.

(1) Services available in countries that have the right structure and capabilities.

| | | | | | | | |
|---------------|----|----------------|----|-----------|----|----------------|----|
| # | | | | | | | |
| 490NTC00005 | 41 | GV2L20 | 60 | VW3A3420 | 37 | VW3A7745 | 50 |
| 490NTC00015 | 41 | GV2L22 | 59 | VW3A3422 | 37 | VW3A7746 | 50 |
| 490NTW00002 | 41 | GV3L25 | 59 | VW3A3423 | 37 | VW3A7750 | 50 |
| 490NTW00002U | 41 | | 60 | VW3A3424 | 37 | VW3A7751 | 50 |
| 490NTW00005 | 41 | GV3L32 | 59 | VW3A3601 | 44 | VW3A7752 | 50 |
| 490NTW00005U | 41 | | 60 | VW3A3607 | 44 | VW3A7753 | 50 |
| 490NTW00012 | 41 | GV3L40 | 59 | VW3A3608 | 42 | VW3A7754 | 50 |
| 490NTW00012U | 41 | GV3L50 | 59 | VW3A3609 | 44 | VW3A7755 | 50 |
| | | | 60 | VW3A3618 | 42 | VW3A7756 | 50 |
| A | | GV3L65 | 59 | VW3A3619 | 44 | VW3A8306R | 40 |
| ATV340D11N4 | 22 | | 60 | VW3A3628 | 43 | VW3A8306R03 | 40 |
| ATV340D11N4E | 23 | L | | VW3A3647 | 44 | VW3A8306R10 | 40 |
| ATV340D11N4S | 25 | LU9GC3 | 40 | VW3A3800 | 48 | VW3A8306R30 | 40 |
| ATV340D15N4 | 22 | N | | VW3A3802 | 45 | VW3A8306RC | 40 |
| ATV340D15N4E | 23 | NSYPTDS4 | 26 | | 48 | VW3A8306TF03 | 40 |
| ATV340D15N4S | 25 | NSYPTDS5 | 26 | VW3A3807 | 46 | VW3A8306TF10 | 40 |
| ATV340D18N4 | 22 | | | | 48 | VW3CANCARR03 | 42 |
| ATV340D18N4E | 23 | P | | VW3A3809 | 47 | VW3CANCARR1 | 42 |
| ATV340D18N4S | 25 | PF151306 | 45 | | 48 | VW3CANKCDF180T | 42 |
| ATV340D22N4 | 22 | | 46 | VW3A4422 | 52 | VW3CANTAP2 | 43 |
| ATV340D22N4E | 23 | T | | VW3A4423 | 52 | VW3E5001R005 | 41 |
| ATV340D22N4S | 25 | TCSCAR013M120 | 42 | VW3A4430 | 26 | VW3E5001R010 | 41 |
| ATV340D30N4E | 23 | TCSCAR01NM120 | 43 | VW3A4431 | 26 | VW3E5001R015 | 41 |
| ATV340D30N4EZ | 24 | TCCTN023F13M03 | 42 | VW3A4432 | 26 | VW3E5001R020 | 41 |
| ATV340D37N4E | 23 | TCCTN026M16M | 43 | VW3A4551 | 54 | VW3E5001R030 | 41 |
| ATV340D37N4EZ | 24 | TCSEGW131W | 30 | VW3A4552 | 54 | VW3E5001R050 | 41 |
| ATV340D45N4E | 23 | TCSMCNAM3M002P | 30 | VW3A4553 | 54 | VW3E5001R100 | 41 |
| ATV340D45N4EZ | 24 | TSXCANCA100 | 42 | VW3A4554 | 54 | VW3E5001R150 | 41 |
| ATV340D55N4E | 23 | TSXCANCA300 | 42 | VW3A4555 | 54 | VW3E5001R200 | 41 |
| ATV340D55N4EZ | 24 | TSXCANCA50 | 42 | VW3A4706 | 52 | VW3E5001R250 | 41 |
| ATV340D75N4E | 23 | TSXCANCADD03 | 43 | VW3A4707 | 52 | VW3E5001R300 | 41 |
| ATV340D75N4EZ | 24 | TSXCANCADD1 | 43 | VW3A4708 | 52 | VW3E5001R400 | 41 |
| ATV340U07N4 | 22 | TSXCANCADD3 | 43 | VW3A4711 | 52 | VW3E5001R500 | 41 |
| ATV340U07N4E | 23 | TSXCANCADD5 | 43 | VW3A4712 | 52 | VW3M2207 | 26 |
| ATV340U07N4S | 25 | TSXCANCB100 | 42 | VW3A47804 | 26 | VW3M2606 | 26 |
| ATV340U15N4 | 22 | TSXCANCB300 | 42 | VW3A47805 | 26 | VW3M3802 | 42 |
| ATV340U15N4E | 23 | TSXCANCB50 | 42 | VW3A5301 | 55 | VW3M4701 | 37 |
| ATV340U15N4S | 25 | TSXCANCBDD03 | 43 | VW3A5302 | 55 | VW3M7101R01 | 26 |
| ATV340U22N4 | 22 | TSXCANCBDD1 | 43 | VW3A5303 | 55 | VW3M7102R150 | 26 |
| ATV340U22N4E | 23 | TSXCANCBDD3 | 43 | VW3A5304 | 55 | VW3M8221R1000 | 37 |
| ATV340U22N4S | 25 | TSXCANCBDD5 | 43 | VW3A5305 | 55 | VW3M8222R1000 | 37 |
| ATV340U30N4 | 22 | TSXCANCD100 | 42 | VW3A5306 | 55 | VW3M8222R250 | 37 |
| ATV340U30N4E | 23 | TSXCANCD300 | 42 | VW3A5501 | 56 | VW3M8222R500 | 37 |
| ATV340U30N4S | 25 | TSXCANCD50 | 42 | | 65 | VW3M8223R30 | 26 |
| ATV340U40N4 | 22 | TSXCANKCDF180T | 42 | VW3A5502 | 56 | VW3M8502R03 | 26 |
| ATV340U40N4E | 23 | TSXCANKCDF90T | 42 | | 65 | VW3M8502R15 | 26 |
| ATV340U40N4S | 25 | TSXCANTDM4 | 43 | VW3A5503 | 56 | VW3M8801R30 | 45 |
| ATV340U55N4 | 22 | V | | | 65 | VW3M8802R15 | 45 |
| ATV340U55N4E | 23 | VW3A1104R10 | 28 | VW3A5504 | 56 | VW3M8802R30 | 45 |
| ATV340U55N4S | 25 | | 30 | | 65 | VW3M8810 | 45 |
| ATV340U75N4 | 22 | VW3A1104R100 | 28 | VW3A7730 | 49 | VW3M8820 | 45 |
| ATV340U75N4E | 23 | | 30 | | 50 | VX5VMS1001 | 26 |
| ATV340U75N4S | 25 | VW3A1104R30 | 28 | VW3A7731 | 49 | VX5VMS2001 | 26 |
| ATVRD15N4 | 58 | | 30 | VW3A7732 | 49 | VX5VMS3001 | 26 |
| ATVRU75N4 | 58 | VW3A1104R50 | 28 | VW3A7733 | 49 | VX5VPS4001 | 26 |
| | | | 30 | VW3A7734 | 49 | VX5VPS5001 | 26 |
| G | | VW3A1111 | 29 | VW3A7735 | 49 | Z | |
| GV2L08 | 59 | VW3A1112 | 30 | VW3A7736 | 49 | ZB5AZ905 | 28 |
| | 60 | VW3A1113 | 27 | VW3A7740 | 50 | | 30 |
| GV2L10 | 59 | VW3A1114 | 28 | VW3A7741 | 50 | | |
| | 60 | VW3A1115 | 30 | VW3A7742 | 50 | | |
| GV2L14 | 59 | VW3A3203 | 38 | VW3A7743 | 50 | | |
| | 60 | VW3A3204 | 38 | VW3A7744 | 50 | | |
| GV2L16 | 59 | VW3A34001 | 26 | | | | |
| | 60 | VW3A34002 | 26 | | | | |
| | 60 | VW3A34003 | 26 | | | | |

Legal information

The information provided in this Catalog contains description of Schneider Electric products, solutions and services ("Offer") with technical specifications and technical characteristics of the performance of the corresponding Offer.

The content of this document is subject to revision at any time without notice due to continued progress in methodology, design and manufacturing.

To the extent permitted by applicable law, no responsibility or liability is assumed by Schneider Electric and its subsidiaries for any type of damages arising out of or in connection with (i) informational content of this Catalog not conforming with or exceeding the technical specifications, or (ii) any error contained in this Catalog, or (iii) any use, decision, act or omission made or taken on basis of or in reliance on any information contained or referred to in this Catalog.

SCHNEIDER ELECTRIC MAKES NO WARRANTY OR REPRESENTATION OF ANY KIND, WHETHER EXPRESS OR IMPLIED, AS TO WHETHER THIS CATALOG OR ANY INFORMATION CONTAINED THEREIN SUCH AS PRODUCTS AND SERVICES WILL MEET REQUIREMENTS, EXPECTATIONS OR PURPOSE OF ANY PERSON MAKING USE THEREOF.

Schneider Electric brand and any trademarks of Schneider Electric and its subsidiaries referred to in this Catalog are property of Schneider Electric or its subsidiaries. All other brands are trademarks of their respective owners.

This Catalog and its content are protected under applicable copyright laws and provided for informative use only. No part of this Catalog may be reproduced or transmitted in any form or by any means (electronic, mechanical, photocopying, recording, or otherwise), for any purpose, without the prior written permission of Schneider Electric.

Copyright, intellectual, and all other proprietary rights in the content of this Catalog (including but not limited to software, audio, video, text, and photographs) rests with Schneider Electric or its licensors. All rights in such content not expressly granted herein are reserved. No rights of any kind are licensed or assigned or shall otherwise pass to persons accessing this information.

Life Is On



Learn more about our products at
www.se.com/drives

The information provided in this documentation contains general descriptions and/or technical characteristics of the performance of the products contained herein. This documentation is not intended as a substitute for and is not to be used for determining suitability or reliability of these products for specific user applications. It is the duty of any such user or integrator to perform the appropriate and complete risk analysis, evaluation and testing of the products with respect to the relevant specific application or use thereof. Neither Schneider Electric nor any of its affiliates or subsidiaries shall be responsible or liable for misuse of the information contained herein.

Design: Schneider Electric
Photos: Schneider Electric

Schneider Electric Industries SAS

Head Office
35, rue Joseph Monier - CS 30323
F-92500 Rueil-Malmaison Cedex
France

DIA2ED2160701EN
February 2025 - V6